

26

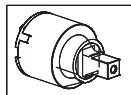

5

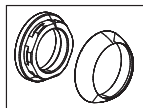

22

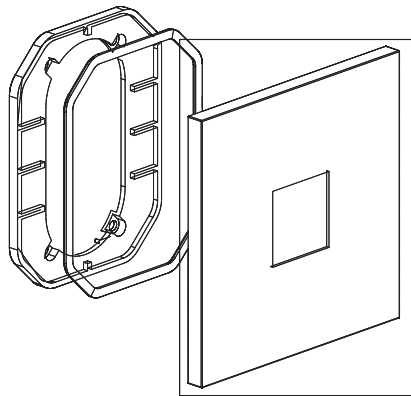

32

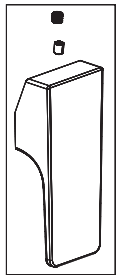

2