

Silent Flow

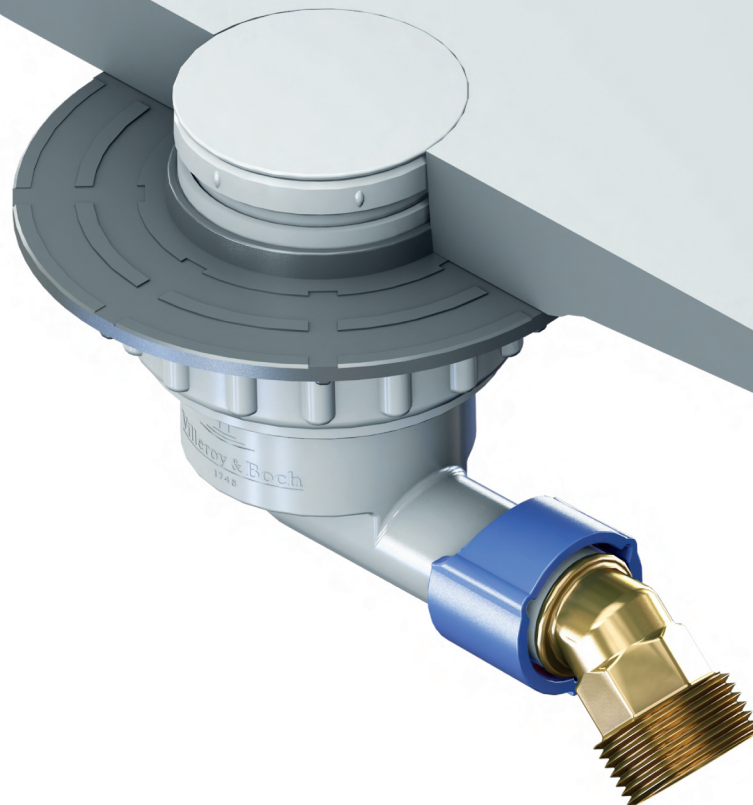

- | | | | |
|---------------------------------------|---------------------------------|---------------------------------|----------------------------------|
| DE Montageanleitung | AR دليل التركيب | HU Szerelési útmutató | PT Instruções de montagem |
| EN Installation instructions | BG Ръководство за монтаж | ID Petunjuk pemasangan | RO Manual de montaj |
| ES Instrucciones de montaje | CS Návod k montáži | JA 取付説明書 | SK Návod na montáž |
| FR Instructions de montage | DA Monteringsvejledning | KO 설치 가이드 | SL Navodila za montažo |
| IT Istruzioni per il montaggio | ET Paigaldusjuhend | LT Montavimo instrukcija | SV Monteringsanvisning |
| NL Montagehandleiding | EL Οδηγίες τοποθέτησης | LV Montāžas instrukcija | TH คู่มือการติดตั้ง |
| RU Инструкция по монтажу | FI Asennusohje | NO Monteringsanvisning | TR Montaj kılavuzu |
| ZH 安装说明 | HR Uputa za montažu | PL Instrukcja montażu | UK Інструкція з монтажу |

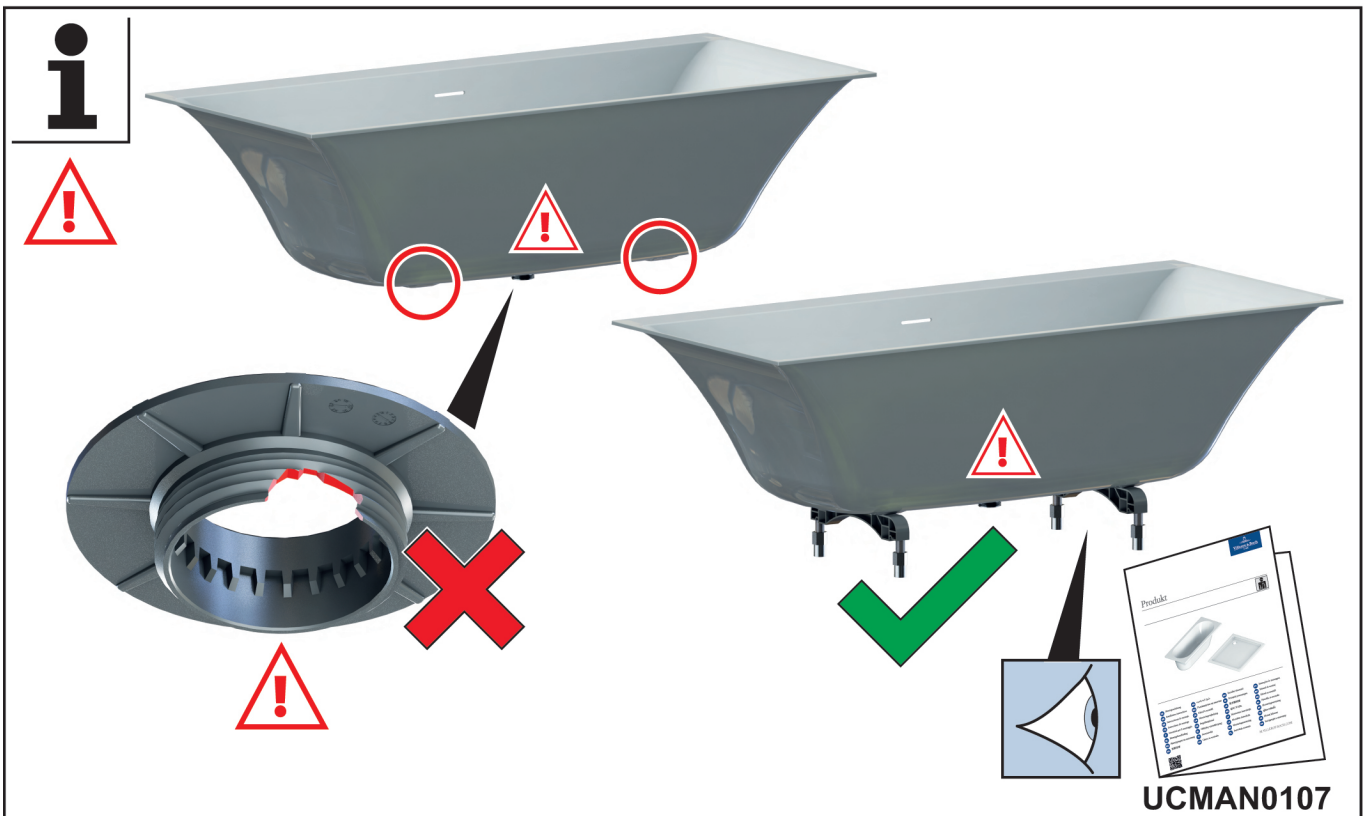

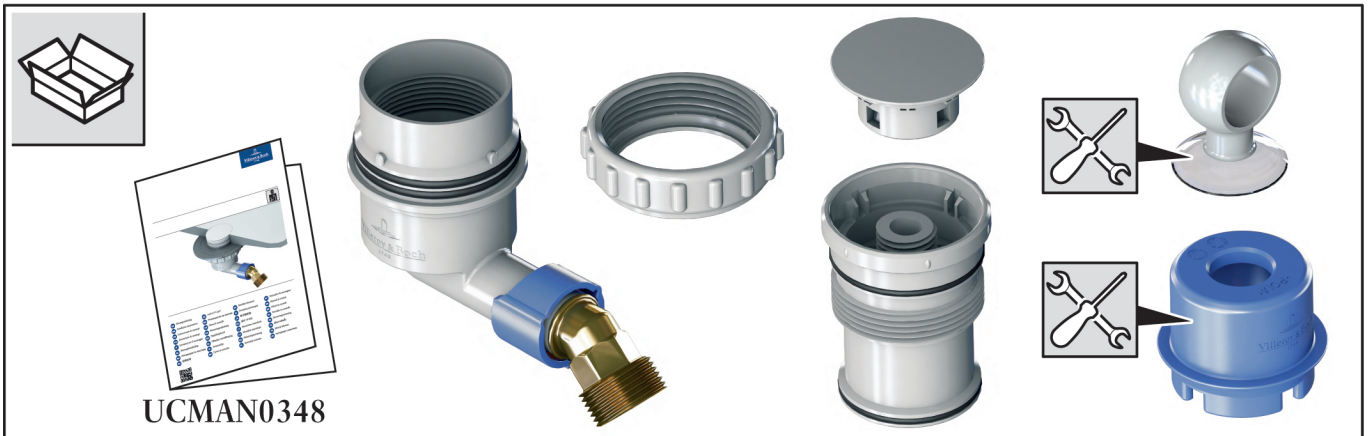

1

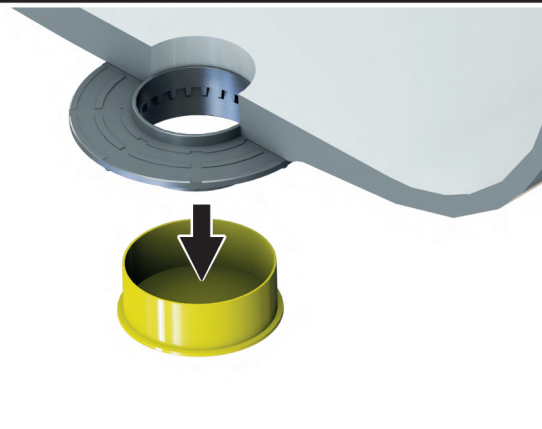

2



3

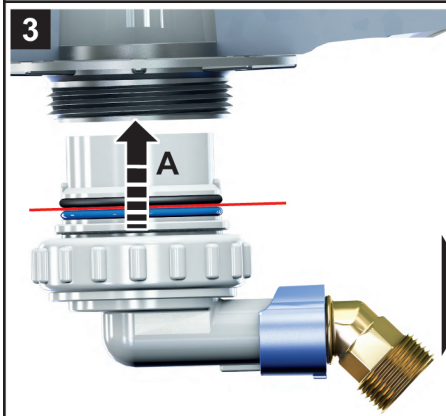

3

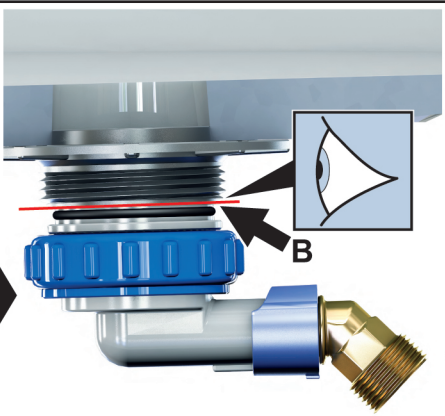

3

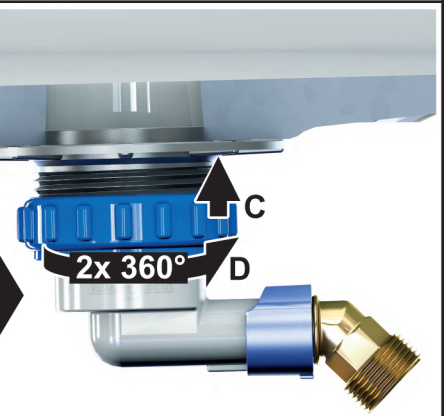

4

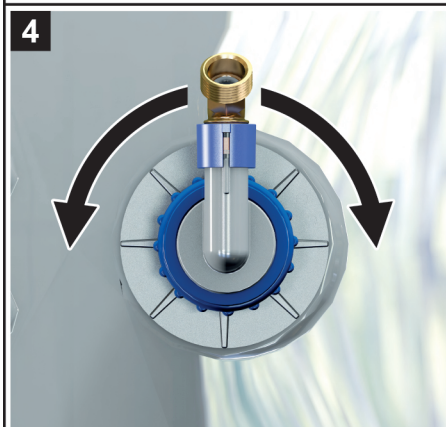

4



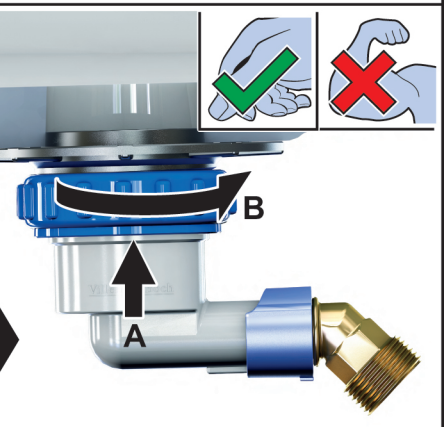

4





i











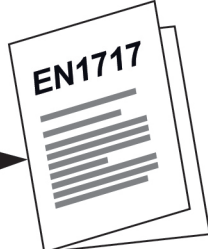

- max. 60 °C
- max. 18 l/min. (±10%) @ 2.5 bar
- max. 3.0 bar
- PH > 4

