

ViClean-IA 全自動電腦馬桶座

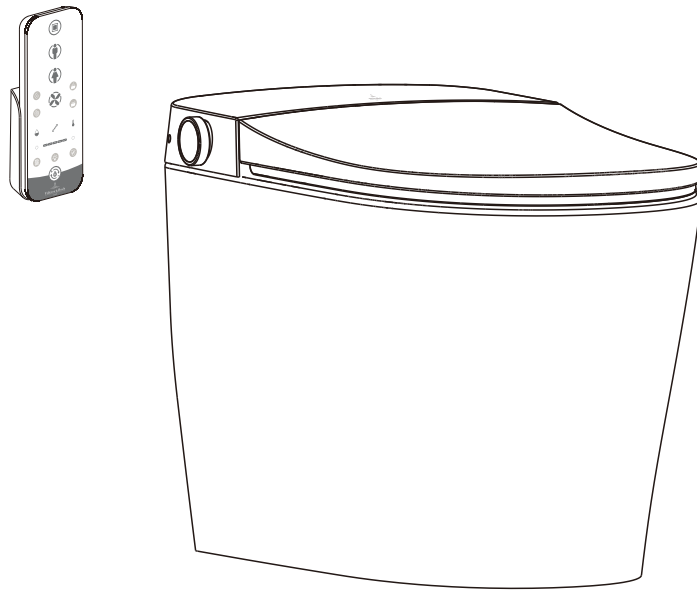

ZH-TW 操作說明

EN Operating instructions

發佈資訊

Villeroy&Boch AG

Saaruferstrasse

66693 Mettlach

德國

www.villeroy-boch.com

未經 Villeroy&Boch AG 書面許可，禁止下載和使用我們網頁上的圖像。

版權

Villeroy&Boch AG

責任

我們的網頁內容經過精心準備。但是，我們對內容的正確性、完整性和最新狀態不承擔任何責任。Villeroy&Boch AG 對其根據一般法律法規提供使用的內容負責。該內容與其他服務提供者經由交叉引用（“連接”）提供的內容不同。如果我們發現鏈接內容會引起民事或刑事責任，我們將刪除這些鏈接。



本產品符合 BSMI 認證標準。
符合性聲明證書可以從 Villeroy
& Boch 獲得。

目錄

1	一般資訊	4
1.1	使用的標識	4
1.2	目標客群	5
1.3	保固	6
2	安全性	7
2.1	適用範圍	7
2.2	可合理預見的誤用	7
2.3	基本安全提示	7
3	技術參數	11
4	產品描述	12
5	操作	14
5.1	清洗設置	15
5.2	停止	16
5.3	沖水	16
5.4	除臭	17
5.5	暖風設置	17
5.6	座蓋和座圈設置	17
5.7	夜燈	18
5.8	噴嘴紫外線殺菌	18
5.9	記憶功能	18
5.10	抗菌	19
5.11	預沖洗功能	19
5.12	旋鈕操作	19
5.13	專家模式	20
5.14	噴嘴清潔	20
5.15	遙控器對頻	20
6	更換電池	21
7	維護和保養	22
7.1	一般保養說明	22
7.2	噴嘴清潔	23
7.3	緊急沖水	23
7.4	過濾器清潔	24
8	故障排除	25
9	處置	27

1 一般資訊

感謝您選擇了我們的高品質產品。

安裝和使用本產品前，請仔細閱讀安裝和操作說明。安裝和操作說明應始終存放在用戶便於取用的位置。

安裝前檢查產品是否損壞和完整。完成安裝後，無法再對明顯缺陷進行糾正。

1.1 使用的標識

安全提示



警告！

警告潛在的危險。
可能造成嚴重人身傷害或死亡。



小心！

警告潛在的危險情況。
可能造成輕度人身傷害或財物損壞。



注意

其他有用的應用提示資訊。

操作提示

要執行的步驟用編號列示。必須遵守步驟順序。

例如：

1. 操作步驟
2. 操作步驟

操作提示的結果如下所示：

例如：

- ⇒ 箭頭
- ⇒ 箭頭

列表

沒有固定時間順序的清單用一組圓點表示。

例如：

- 項 1
- 項 2

1.2 目標客群

本操作說明的目標客群為產品使用者。

用戶：

兒童以及生理、感官或精神機能不足或缺乏經驗和/或知識的人員，可在接受安全使用監督或指導並瞭解潛在危險的情況下使用本產品。不應讓兒童玩耍本產品。



警告！

兒童只能在監督下進行清潔和使用維護。

1.3 保固

您的新ViClean-IA全自動電腦馬桶座從設計到製造極盡精打細作，展現完美細節。它以高品質、耐用和迷人的優雅而著稱。這是我們對您的承諾並為您提供12個月的保固。

在下列情況下，我們拒絕保固理賠：

- 不可抗力，如火災、地震、洪水、風暴或環境污染、氣體侵蝕(硫化氫氣體)、鹽蝕和電壓變化等其他影響造成的損害或損失
- 不按照安裝說明進行安裝造成的損壞或損失
- 使用不當誤用、無視操作說明或者違反操作說明中的規範對產品維護不當/缺乏維護造成的損壞或損失
- 改造或銷毀產品造成的損壞或損失
- 水路系統中的水漬、沉積物或異物造成的損壞或損失
- 產品使用地區的水質造成的損壞或損失
- 安裝不當或者安裝後拆卸造成的損壞或損失
- 危險環境造成的損壞或損失
- 外部影響(例如座蓋變形)造成的損壞或損失
- 動物或昆蟲造成的損壞或損失
- 產品凍結造成的損壞或損失
- 非特定電源(電壓、頻率)和產品外部電磁波(例如高壓線路或配件產生的)造成的損壞或損失
- 電池電量不足造成的損壞或損失
- 磨損(例如過濾器、O型圈或密封件)造成的損壞或損失

2 安全性

2.1 適用範圍

本產品為第 I 類電氣設備，必須接地。只能在乾燥環境中使用。如果要在浴室中使用本產品，必須確保充分通風。為此需安裝排氣扇或通風系統。

正常使用還包括：

- 遵守所有操作說明。
- 遵守所有安裝說明。
- 僅使用原裝備件。
- 僅在室內使用本產品。

ViClean-IA 只可使用清水。水中的污垢會堵塞過濾器、軟管和噴嘴。

2.2 可合理預見的誤用

除“適用範圍”以外的或超出此範圍的任何使用，均視為不當使用。製造商對使用不當造成的損壞不承擔任何責任；由使用者承擔全部責任。

2.3 基本安全提示

電力



警告！

觸電危險！

接觸帶電部件可能導致重傷甚至死亡。

- 本產品的工作電壓為 110 V，60 Hz。本產品只能由合格的專業人員安裝和維修。
- 作業時，確保已切斷主電源並防止其重新接通。



警告！

清潔和維護時存在觸電危險！

清潔和維護時接觸帶電元件 (110 V，60 Hz) 可能導致重傷甚至死亡。

- 清潔和維護時切勿接觸帶電部件 (110 V，60 Hz)。



警告！

觸電危險！

帶電元件安裝或固定不當可能導致重傷甚至死亡。

- 所有電氣和電磁元件，以及安裝所需的元件 (遙控器除外) 必須按照安裝說明和所在國適用的法律法規安全地連接到馬桶上。
- 為了防止傷害甚至死亡，所有帶電部件必須按照安裝說明和所在國適用的法律法規安全地連接到馬桶上。

熱源



警告!

爆炸危險!

馬桶或遙控器周圍的熱源可能導致產品發熱並爆炸。

- 請勿將熱源置於馬桶或遙控器周圍。

清潔



警告!

兒童只能在監督下進行清潔和使用維護。



小心!

清潔劑會造成財物損壞!

使用非PH中性清潔劑或者含氯或磨蝕性清潔劑，以及使用表面粗糙的清潔用具接觸智慧座廁可能導致損壞。

- 只能用水、溫和的中性清潔劑和表面柔軟的抹布清潔全自動電腦馬桶座。
- 如果全自動電腦馬桶座接觸到腐蝕性清潔劑或衛生清潔劑，請立即用濕布將清潔劑擦拭乾淨。



小心!

清潔劑會造成財物損壞!

座圈和座蓋可能因接觸清潔劑而損壞。

清潔時，確保座圈和座蓋保持打開狀態，在使用清潔劑去除較嚴重的髒汙後，使用濕布將清潔劑擦拭乾淨。



小心!

水會造成財物損壞!

遙控器可能因接觸水而損壞。

- 切勿將遙控器浸入水中。
- 請勿用洗碗機清潔遙控器。

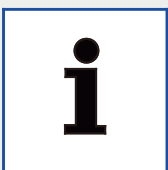

注意

若要清潔馬桶座圈，請使用溫和的肥皂液，並確保馬桶座和後鈕不會受潮。

因此，用軟布擦乾馬桶座圈和後鈕。

操作



注意

如果產品出現故障，用適當的開關關閉馬桶（參見“產品描述”章節）並切斷供水。故障可能包括：

- 冒煙
- 漏水
- 發出雜音



注意

必須使用隨機配套的三角凡爾和軟管元件，舊三角凡爾和軟管元件不能繼續使用。

進水軟管不能過度彎折，以免影響給水，造成使用故障。



注意

- 本系統符合第 I 類保護等級的設備的要求。
- 如果電源線損壞，為避免危險，必須由製造商、其服務代理商或類似的合格人員更換。
- 所有部件必須安裝在正確的部位。
- 請勿使用膠黏劑為固定方式。



注意

在硬水地區，水垢的形成可能會影響產品的性能。

檢查您所在地區的水質。如果水的硬度 $\geq 14^\circ$ dH (2.5 mmol/l)，建議安裝軟水器。



注意

當座圈和座蓋放下時，避免其承受任何不符合使用規範的重量，例如不要站在座圈或座蓋上或者用一條腿支撐自己。



注意

使用手套正確處置漏液電池。避免皮膚接觸。
用濕布擦去殘留物。



注意

僅可使用LR03/AAA鹼性電池。切勿使用充電電池。



注意

存在身體、感知、智力能力缺陷或對經驗和常識缺乏者不能使用本產品。
若想使用時必須由安全負責人對產品的使用進行監督或指導。



注意

兒童、老人、肢體及智力殘缺或經驗和常識缺乏者必須有監護人陪同才可使用。
不要讓兒童玩耍器具，以免造成人身或器具的傷害。



注意

周圍不放置煙火等易燃物品，否則可能導致火災。
點燃的香煙及其他燃燒物不能投入座便器內，以免發生火災！



注意

如果電源線損壞，必須用專用電線或從其製造商或維修部買到的專用元件來更換。



注意

上電復位

機器通電後，主機板檢測到交流電信號，對分配閥、清洗器進行復位自檢動作、所有燈光全部點亮，座溫、水溫、風溫、水壓、噴嘴位置恢復至中段位置。自檢結束時進入開機狀態。操作時有提示音，“咚”為正確提示音，“叮”為異常提示音。



國家通訊傳播委員會（NCC）警語

LP0002低功率射頻器材技術規範_章節3.8.2

取得審驗證明之低功率射頻器材，非經核准，公司、商號或使用者均不得擅自變更頻率、加大功率或變更原設計之特性及功能。低功率射頻器材之使用不得影響飛航安全及干擾合法通信；經發現有干擾現象時，應立即停用，並改善至無干擾時方得繼續使用。前述合法通信，指依電信管理法規定作業之無線電通信。低功率射頻器材須忍受合法通信或工業、科學及醫療用電波輻射性電機設備之干擾。

3 技術參數

類別		說明
型號		V15TA301(管距305mm), V15TA401(管距400mm)
產品名稱		ViClean-IA 全自動電腦馬桶座
額定電壓/頻率		110 V~ 60 Hz
額定消耗功率		1050 W ※1
最大功率		1600 W
遙控器電池 (2個)		類型: LR03/AAA
座廁沖水方式		自動沖水、遙控沖水、緊急沖水
座廁用水量		大沖4.2 L, 小沖3.0 L
清洗功能	最大水流量 (水壓0.2 MPa時)	不少於500 mL/min
	水加熱溫度	Off/約34-39 °C
		4段
	可調噴嘴位置	5段
	加熱器功率	約1400 W
清洗強度	3段	
座圈	座圈表面加熱溫度	Off/約34-39 °C
		4段
	加熱器功率	約40 W
暖風	暖風溫度	Off/約35-55 °C ※3
		4段
	風量	約0.2 m ³ /min
		3段
	加熱器功率	約350 W
除臭	方式	觸媒
防水等級		IPX4
進水溫度		4-35 °C
操作環境溫度		4-40 °C
水壓要求		0.08 MPa(動壓)-0.75 MPa(靜壓) ※2
尺寸(長 x 寬 x 高)		685x400x470 mm
電源線長度		1.6 m
重量		45 kg

※1 進水溫度15 °C。

※2 水壓要求的測試條件, 使用產品自帶三角凡爾, 在動壓0.08 MPa, 流量13.8 L/min。

※3 據規定於出風口附近測得的溫度。

4 產品描述

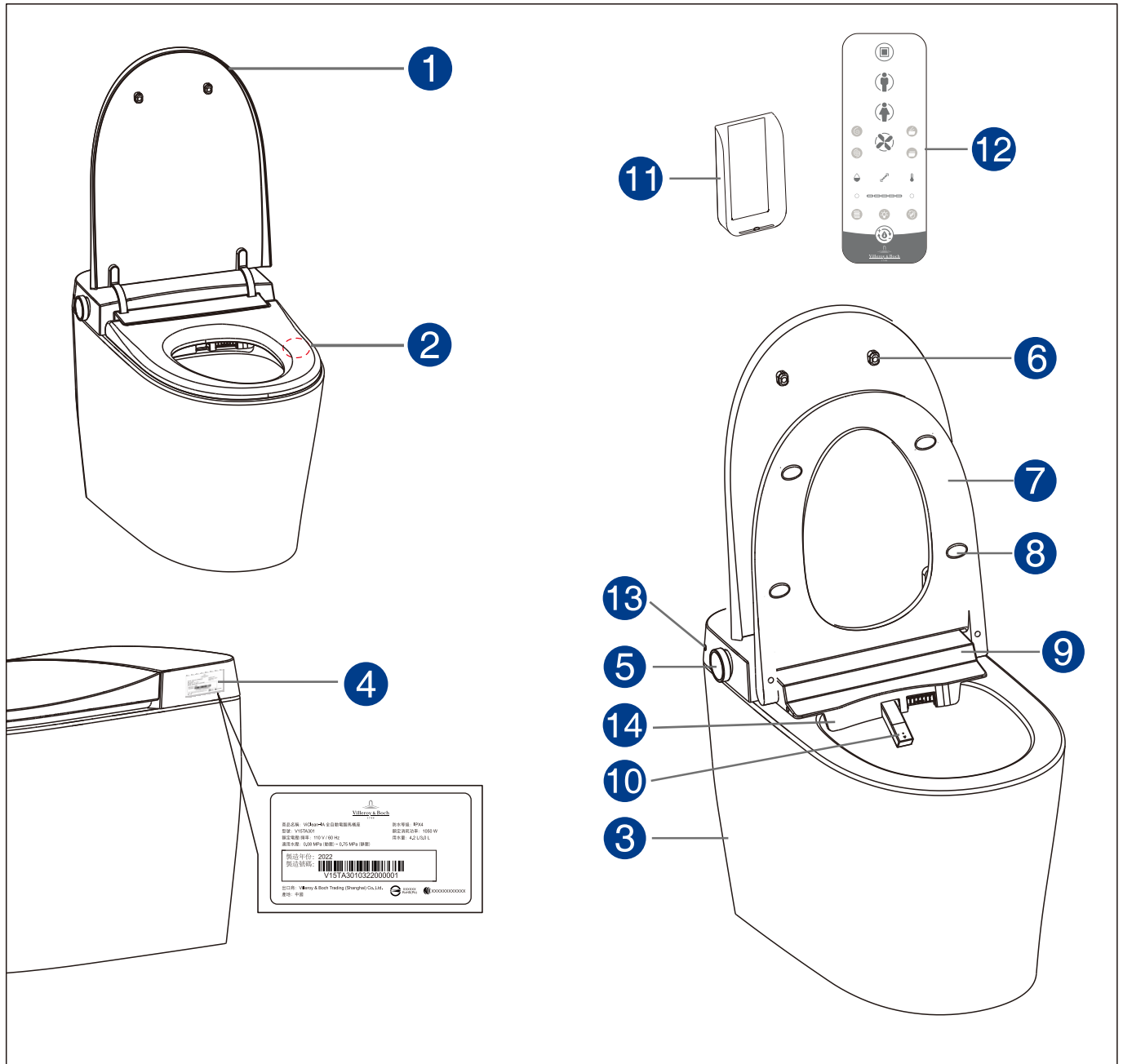

- | | |
|-----------------|--------------|
| 1 座蓋 | 8 座圈緩衝墊 |
| 2 座圈感測器 | 9 後蓋 |
| 3 陶瓷體 | 10 噴嘴 |
| 4 帶序列號的產品銘牌 | 11 遙控器壁掛支架 |
| 5 側面控制旋鈕(狀態指示燈) | 12 遙控器 |
| 6 座蓋緩衝墊 | 13 光感窗口 |
| 7 座圈 | 14 夜燈(在底座下方) |

噴嘴設置

女士清洗和臀部清洗均可選擇以下設置：

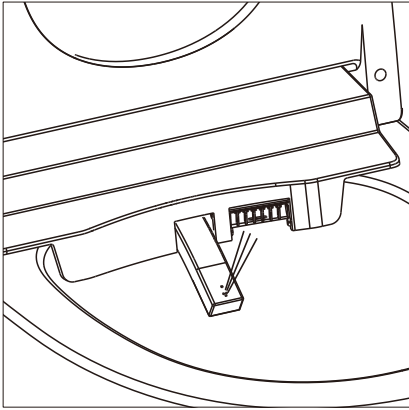

正常
以連續的水流定位清洗

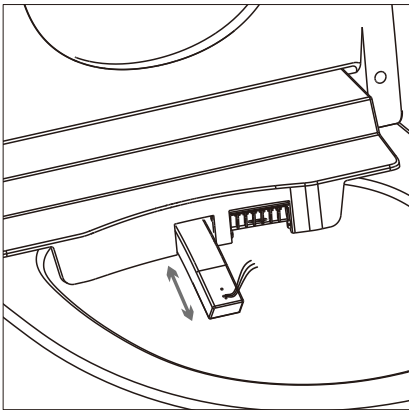

擺動
伴隨著擺動進行清洗

5 操作

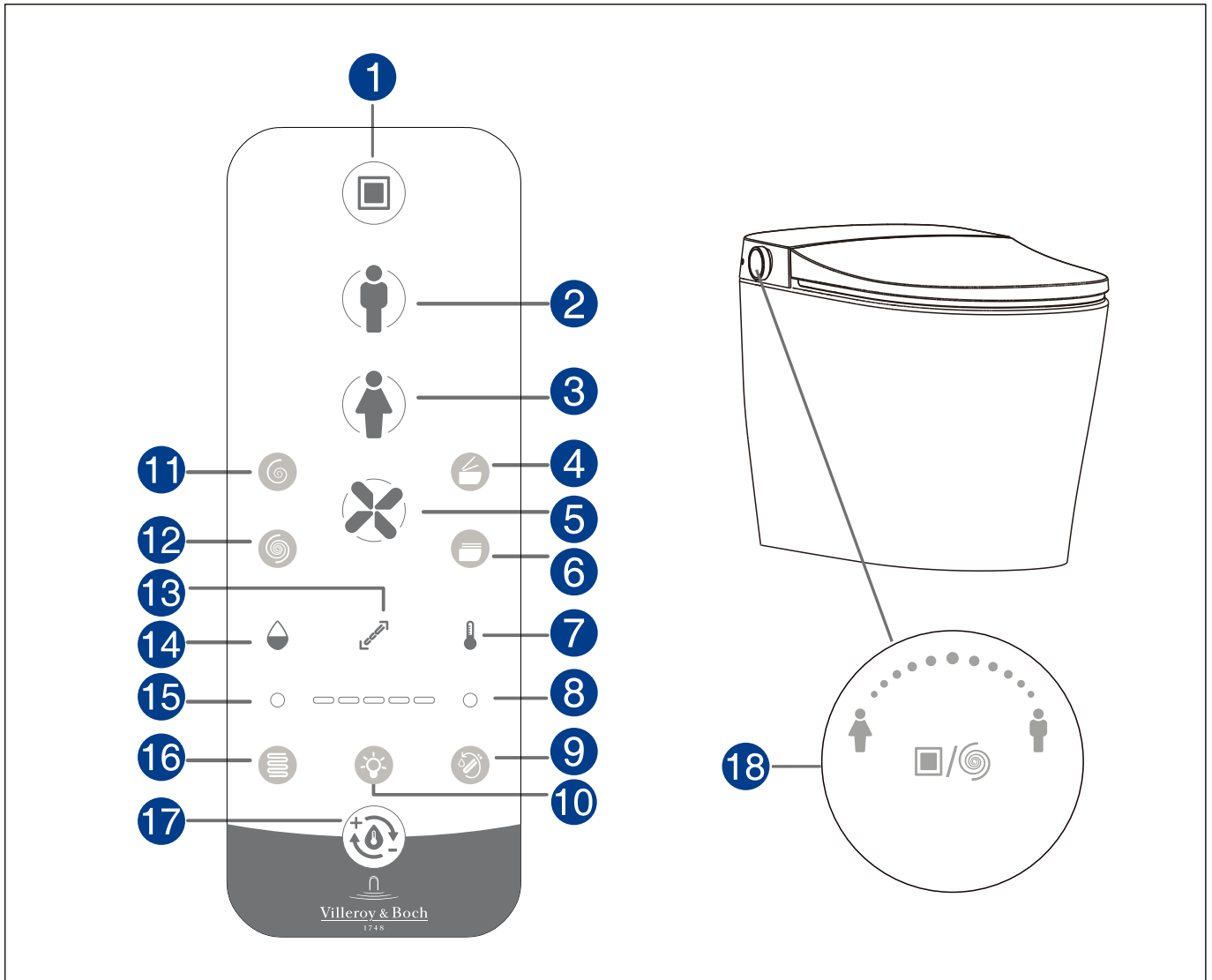

- | | |
|----------|-----------------|
| 1 停止 | 10 夜燈設置 |
| 2 臀部清洗 | 11 小沖水 |
| 3 女士清洗 | 12 大沖水 |
| 4 開座蓋/座圈 | 13 噴嘴位置 |
| 5 暖風 | 14 清洗強度 |
| 6 關座蓋/座圈 | 15 減小檔位 |
| 7 水溫調節 | 16 座溫調節 |
| 8 增加檔位 | 17 冷熱按摩 |
| 9 噴嘴清洗 | 18 旋鈕操作參照5.12章節 |

5.1 清洗設置

清洗功能僅在用戶坐在座圈上時可用。

臀部清洗

啟動清洗時，初始模式為擺動按摩清洗，側邊旋鈕指示燈為藍色，按下停止鍵停止或等待4分鐘自動停止。

按鈕	頻率	結果
	1下	擺動按摩清洗。
	2下	正常清洗。

女士清洗

啟動清洗時，初始模式為擺動按摩清洗，側邊旋鈕指示燈為粉紅色，按下停止鍵停止或等待4分鐘自動停止。

按鈕	頻率	結果
	1下	擺動按摩清洗。
	2下	正常清洗。

冷熱按摩清洗

在清洗模式下，水溫冷熱交替清洗，該功能只能在臀洗/婦洗進程中打開/關閉。

按鈕	頻率	結果
	1下	在清洗模式下，啟動冷熱按摩。
	2下	在清洗模式下，關閉冷熱按摩。

噴嘴位置

在正常清洗時，可以在五個不同段位間調節噴嘴位置。啟動清洗時，初始位置為上一次設置的位置段位。

按鈕	頻率	結果
	1下	開始調節噴嘴位置，LED檔位燈指示噴嘴的位置。
○ ○ ○ ○ ○ ●	1下	噴嘴位置前移一檔。
● ○ ○ ○ ○ ○	1下	噴嘴位置後移一檔。

清洗強度

啟動清洗時，初始強度為上一次設置的強度段位。

臀部清洗或者女士清洗運行期間，可以在三個不同段位間調節清洗強度。

按鈕	頻率	結果
	1下	開始調節水力，LED檔位燈指示水力設置。
○ ○○○○○ ●	1下	水力增加一檔。
● ○○○○○ ○	1下	水力減小一檔。

* 清洗強度也可以通過主機上“功能旋鈕”調節，參見功能旋鈕操作章節。

水溫

啟動清洗時，初始溫度為上一次設置的段溫度。

臀部清洗或者女士清洗運行期間，可以在四個不同段位間調節水溫（包括不加熱）。

按鈕	頻率	結果
	1下	開始調節清洗水溫，LED檔位燈指示溫度設置。
○ ○○○○○ ●	1下	清洗水溫增加一檔。
● ○○○○○ ○	1下	清洗水溫減小一檔。

5.2 停止

按鈕	操作	結果
	按下停止	停止清洗或暖風功能。

5.3 沖水

遙控器沖水

水箱需要間隔一段補水的時間才能再次沖水。

大沖

按鈕	操作	結果
	1下	啟動全沖水，側邊旋鈕指示燈在執行沖洗時為藍色。

小沖

按鈕	操作	結果
	1下	啟動半沖水，側邊旋鈕指示燈在執行沖洗時為藍色。

自動沖水

功能	進入條件	結果
離座自動沖水	離座	著座時，沒有進行沖水命令，離座短時間後會根據著座時間的長短自動執行大沖或小沖。
關蓋自動沖水	座圈和座蓋打開狀態	人離開後微波感應無人，自動關閉座圈和座蓋並執行小沖。

5.4 除臭

除臭功能在您坐下時自動開啟，清洗或者暖風乾燥功能開啟後，將自動暫停此功能，在清洗或暖風乾燥功能停止後，除臭功能將自動重新啟動，並在您離座後3分鐘後停止。

5.5 暖風設置

暖風烘乾僅在用戶坐在便座上使用。

暖風溫度可以在四個不同段位間調整(包括不加熱)。啟動暖風時，初始溫度為上一次設置的段位。

按鈕	頻率	結果
	1下	啟動暖風，LED檔位燈指示溫度設置。
	1下	暖風風溫增加一檔。
	1下	暖風風溫減小一檔。

暖風風速可以在三個不同段位間調整。

按鈕	結果
	按下"暖風"按鍵，進入烘乾模式，再次按下「暖風」按鍵，可依序由低到高進行3段風速調整。

5.6 座蓋和座圈設置

開/關座圈和座蓋功能僅在無人著座時才可以使用。

座蓋座圈設置

開/關座圈和座蓋

按鈕	頻率	結果
	1下	當座蓋關閉時，打開座蓋。
		當座蓋打開時，打開座圈。
		當座圈和座蓋都開著時，無動作。
	1下	當座蓋關閉時，無動作。
		當座蓋打開時，關閉座蓋。
		當座圈和座蓋都開著時，關閉座圈和座蓋。

整機上電自檢過程中請勿妨礙座圈和座蓋的自檢動作。

自動開/關座圈和座蓋

功能	進入條件	結果
自動開蓋	座蓋關閉狀態，微波感應到人靠近	打開座蓋
自動關蓋	座蓋打開狀態，座圈關閉狀態，微波感應無人靠近短時間後	關閉座蓋
自動關座圈和座蓋	座圈和座蓋打開狀態，微波感應無人靠近短時間後	自動關閉座圈和座蓋並沖水

座蓋完全關閉後需較短時間間隔，才能再次自動感應開啟座蓋。

座圈溫度

可以在四個不同段位間調節座圈溫度。

按鈕	頻率	結果
	1下	開始調節座圈溫度，LED檔位燈指示溫度設置。
○ ○○○○○ ●	1下	圈溫增加一檔。
● ○○○○○ ○	1下	圈溫減小一檔。

5.7 夜燈

可以在三個不同設置間調節夜燈。（關>自動>常開）

夜燈在自動模式下會根據環境亮度自行打開和關閉。夜燈在自動和常開狀態，僅在座蓋打開時打開夜燈。關閉座蓋同時關閉夜燈。

按鈕	頻率	結果
	1下	開始夜燈調節，LED檔位燈指示當前設置。
○ ●●●○○ ●	1下	夜燈由光感自動控制、三個LED檔位燈亮。
○ ●●●●● ●	1下	夜燈常開，LED檔位燈全亮。
● ○○○○○ ○	1下	夜燈常關，LED檔位燈全滅。

5.8 噴嘴紫外線殺菌

操作方式：離座自動進行

功能描述：離座且清洗噴管退回到位，10秒後自動啟動噴嘴紫外線殺菌功能3min 指示燈顏色紫色

[著座]指令後：立刻停止紫外線殺菌功能，指示燈熄滅。

5.9 記憶功能

斷電後，水溫、水壓、風溫、座溫、噴嘴位置均為斷電恢復中段。夜燈斷電後則為自動，調整設置後，保持最後一次記憶設置狀態。

5.10 抗菌

座圈使用抗菌材料。

抗菌(※抗菌力在細菌不直接接觸抗菌加工產品表面時,無法發揮功效。)

抗菌效果	採用可抑製表面細菌繁殖的塑料材料。在JNLA認定試驗所實施該JIS Z 2801抗菌性試驗方法的試驗,其結果符合JIS Z 2801規定的抗菌效果。該試驗效果不具有防止感染、防汗、防霉、防臭、防滑等輔助性效果。
------	---

5.11 預沖洗功能

預沖水功能在您著座位後自動啟動,少量的水將沖洗陶瓷表面,時間設定為水流一圈,確保馬桶內部潤濕。

5.12 旋鈕的操作

功能旋鈕操作

功能	狀態	操作	結果
開機	在待機狀態時	長按旋鈕3秒	進入開機模式
待機	在開機狀態時,無臀洗,婦洗,烘乾	長按旋鈕3秒	進入待機模式
停止	在臀洗,婦洗,烘乾時	短按旋鈕	停止當前功能
智能臀洗	開機時,著座且無清洗或者烘乾	前旋45°以上	進入智能臀洗,旋鈕藍色燈光
智能婦洗	開機時,著座且無清洗或者烘乾	後旋45°以上	進入智能婦洗,旋鈕粉紅色燈光
清洗強度調節	智能臀/婦洗模式或臀部/女士清洗時	前旋45°以上	增加清洗強度
		後旋45°以上	降低清洗強度
暖風強度調節	暖風烘乾時	前旋45°以上	增加風速
		後旋45°以上	降低風速
沖水	開機時,無臀洗,婦洗,烘乾	短按旋鈕	啟動沖水,旋鈕湖藍色燈光

5.13 專家模式

按照以下步驟，開啟/關閉專家模式：

- ▶ 長按 “○ ○○○○ ●” 和 “● ○○○○ ○” 3秒，LED檔位燈閃爍三次，開啟專家模式。

自動翻蓋設置，進入專家模式後

按鈕	頻率	結果
	1下	開始自動翻蓋設置，主機蜂鳴提示當前設置。
○ ○○○○ ●	1下	自動開關蓋打開，主機一聲長響。
● ○○○○ ○	1下	自動開關蓋關閉，主機兩聲短響。

或關蓋沖水設置，進入專家模式後

關蓋沖洗模式下，通過遙控器和側邊旋鈕觸發沖洗時，先關閉座圈和座蓋，然後執行沖洗。

* 此模式下無自動沖洗。

按鈕	頻率	結果
	1下	開始關蓋沖水設置，主機蜂鳴提示當前設置。
○ ○○○○ ●	1下	關蓋沖洗打開，自動沖洗關閉，主機一聲長響。
● ○○○○ ○	1下	關蓋沖洗關閉，自動沖洗打開，主機兩聲短響。

- ▶ 按 “” 退出專家模式，或10秒無任何按鍵，自動退出專家模式。

5.14 噴嘴清潔

有關噴嘴清潔的更多資訊，請參見 [章節7.2, "噴嘴清潔"](#)。

5.15 遙控器對頻

1. 拔下產品插頭，長按遙控器停止鍵直至其檔位燈閃爍後鬆開。
2. 將遙控器靠近產品後插上產品插頭，產品進行復位動作。
3. 檔位燈停止閃爍後常亮，此時對頻成功。



6 更換電池

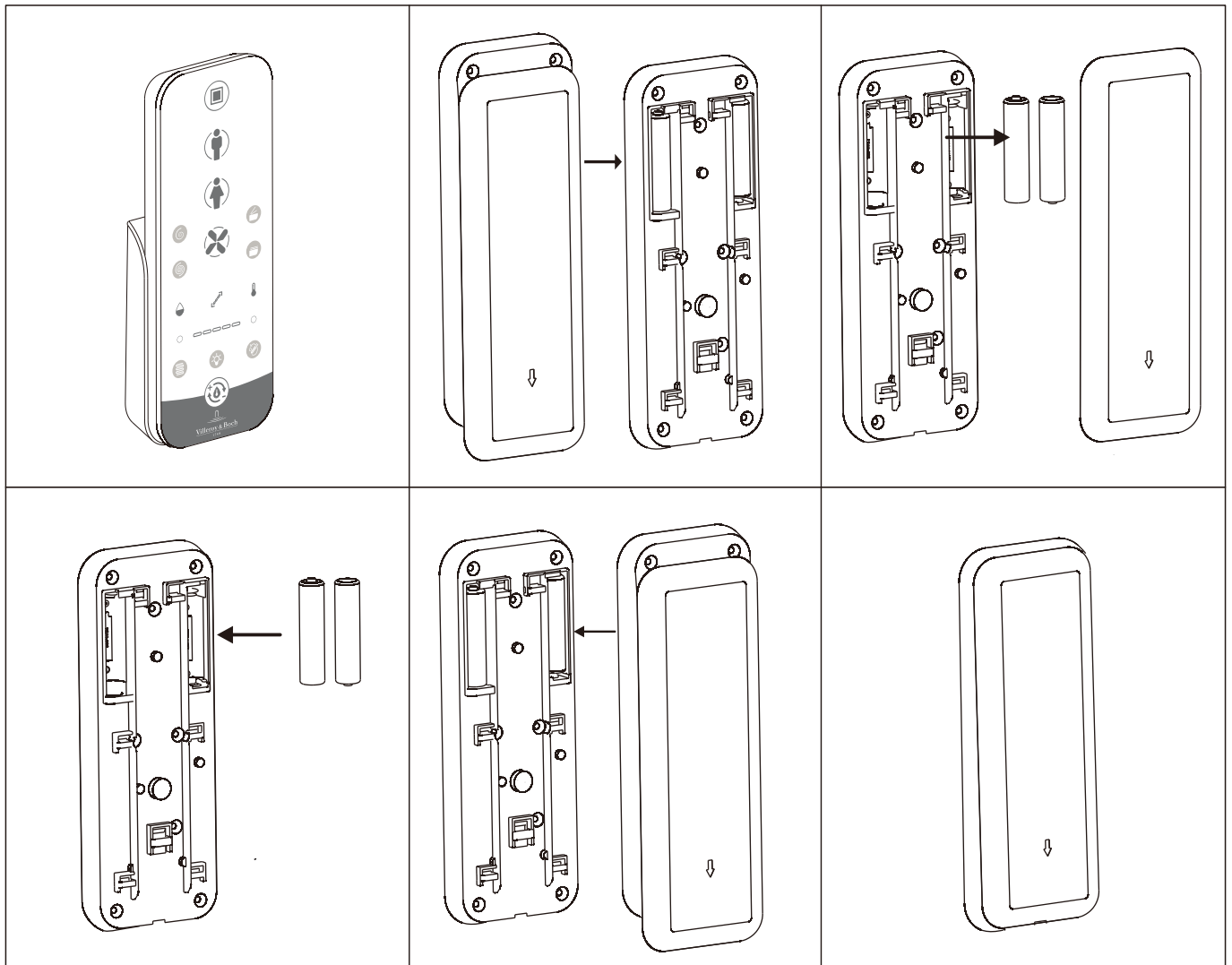

注意

使用手套正確處置漏液電池。避免皮膚接觸。
用濕布擦去殘留物。



注意

僅可使用LR03/AAA鹼性電池。切勿使用充電電池。

為了正確處置電池，請參見 [章節，"處置"](#)。

7 維護和保養



小心!

清潔劑會造成財物損壞!

使用非PH中性清潔劑或者含氯或磨蝕性清潔劑，以及使用表面粗糙的清潔用具接觸智慧座廁可能導致損壞。

- 只能用水、溫和的中性清潔劑和表面柔軟的抹布清潔智能座廁。
- 如果智慧座廁接觸到腐蝕性清潔劑或衛生清潔劑，請立即用清水清洗乾淨。



小心!

水會造成財物損壞!

遙控器可能因接觸水而損壞。

- 切勿將遙控器浸入水中。
- 請勿用洗碗機清潔遙控器。



出差或外出旅遊超過兩周不用時請排空水箱並取出遙控器的電池。

排空水箱

請按照如下步驟排空產品內部餘水

1. 先關閉供水凡爾，再按一下遙控器上的遙控沖水按鍵，陶瓷進行兩次或以上排水。
2. 排水30秒後，請您務必拔掉電源插頭。

7.1 一般保養說明

對於日常清潔，我們建議使用柔軟的非研磨性海綿或抹布。



注意

若要清潔馬桶座圈，請使用溫和的肥皂液，並確保馬桶座和後鈕不會受潮。

因此，用軟布擦乾馬桶座圈和後鈕。

宿垢的保養說明

得益於ViClean-IA易於保養的表面，您可以在不使用腐蝕性除垢劑的情況下獲得最衛生的潔淨表面。如果您想使用除垢劑，我們建議使用標準通用清潔劑。



小心!

清潔劑會造成財物損壞!

座圈和座蓋可能因接觸清潔劑而損壞。

清潔時，確保座圈和座蓋保持打開狀態，在使用清潔劑去除較嚴重的髒汙後，使用濕布將清潔劑擦拭乾淨。

7.2 噴嘴清潔

伸出噴嘴

1. 未著座的情況下按下遙控器上的“”噴嘴清洗鍵。

▶ 噴嘴伸出，可使用濕布清潔。

2. 著座、觸發遙控器和本體任何按鈕退出噴嘴清洗模式或等待四分鐘，噴嘴自動縮回。

※切勿用力過猛，否則會損壞噴嘴。

※當噴嘴堵塞並無法用清潔使其恢復正常時，建議更換新噴嘴。

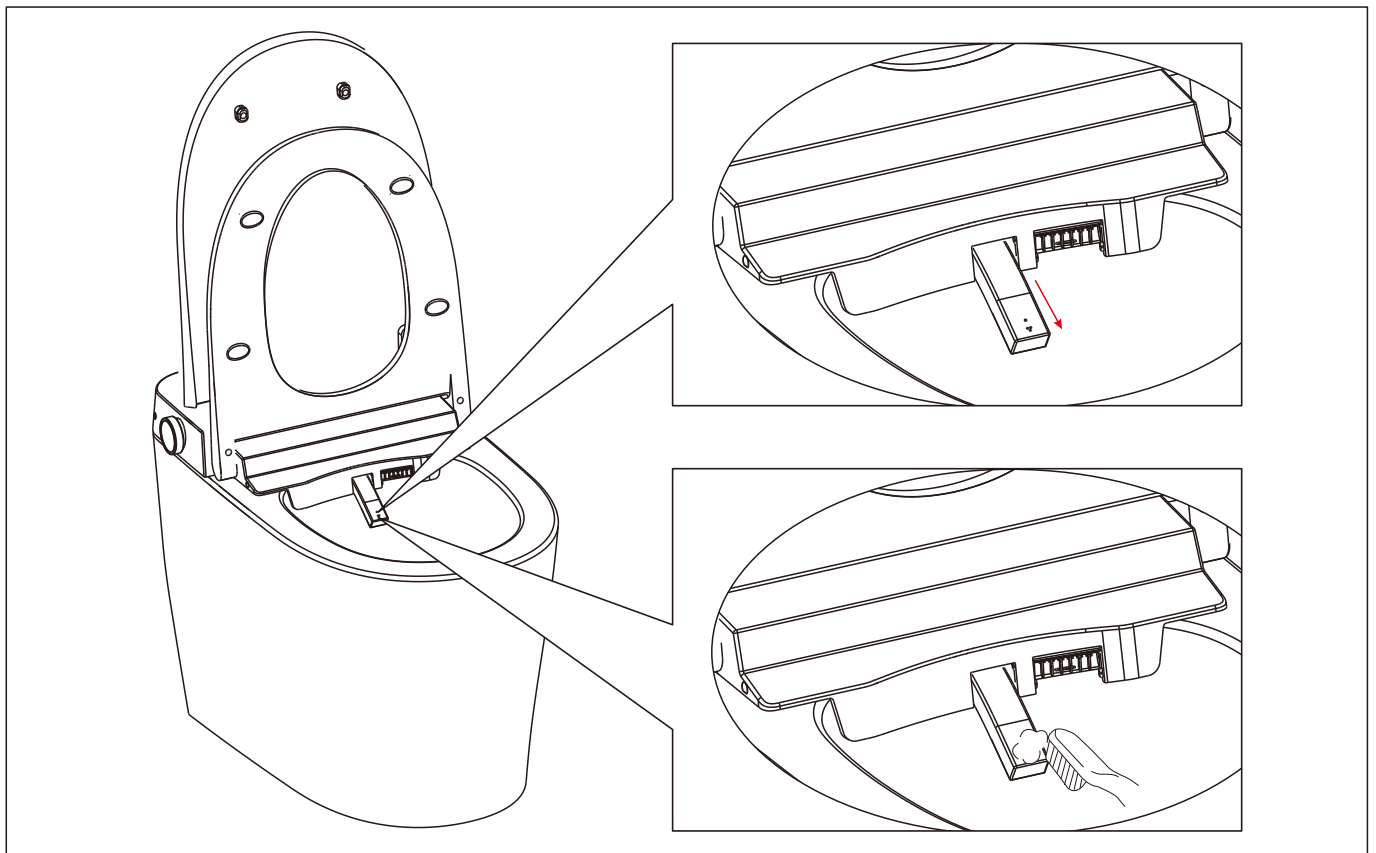

7.3 緊急沖水

停電情況下，短按產品上側邊旋鈕，可執行停電沖水功能。

7.4 過濾器清潔

1 請關閉三角凡爾
停止給水。

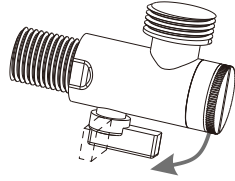

2 拆開過濾網。

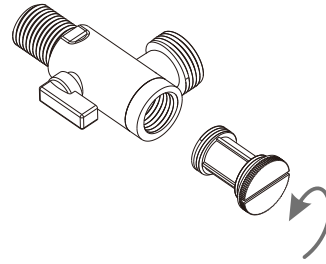

3 清理過濾網, 可使
用牙刷和軟布清潔。



4 安裝過濾網。

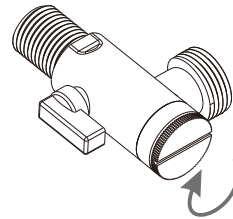

8 排除故障

使用下表排查故障。

排查故障	
檢查供水	您住所的供水是否正常？
	主閥是否關閉？
檢查電源	是否停電？
	檢查浴室的漏電斷路器並重置(如果適用)。
	檢查插頭上的指示燈是否亮起，若未亮，請試按中間復位開關。
重新調整ViClean-IA	關閉ViClean-IA，一分鐘後再開啟。
檢查遙控器是否正常工作。	檢查電池是否耗盡。如果是，請更換電池。 防止遙控器與水接觸。

使用下表排除故障。

故障	可能的解決方案
ViClean-IA無法正常工作	請檢查電源。
ViClean-IA不回應遙控器	檢查遙控器中是否正確放入電池。
	檢查在按下按鈕時，遙控器上對應的清洗強度、噴嘴位置和溫度指示燈是否點亮。 如果沒有，請更換電池。
儘管遙控器上的燈亮起，但ViClean-IA沒有回應	請重新對頻遙控器。(參見 5.15)
	如果無法操作，請聯繫我們的客戶服務部門。

故障	可能的解決方案
水壓不足	用遙控器提高設置。
	清潔過濾器。(參見7.4 過濾器清潔)
	如有必要，擰緊所有水路連接螺母。
水溫不足	用遙控器提高水溫。
	如果浴室內的溫度很低，那麼初始清洗水溫也會很低。
	如果無法操作，請聯繫我們的客戶服務部門。
座圈不加熱	檢查座圈溫度是否設置關閉，用遙控器提高座溫。
噴嘴無法伸出	關閉ViClean-IA，幾秒鐘後再開啟。
	如果無法操作，請聯繫我們的客戶服務部門。
噴嘴伸出過慢	啟用女士清洗或臀部清洗功能時，噴嘴在伸出前會進行幾秒鐘的清潔。這是正常的，並非故障。
噴嘴突然停止噴水	4分鐘後停止清洗，噴頭自動重新收回。這是正常的。
緊急沖水功能不工作	如果無法操作，請聯繫我們的客戶服務部門。

出廠設定					
水溫	中段	水力	中段	噴嘴位置	3段
圈溫	中段	風溫	中段	夜燈	自動
自動沖水	開啓	自動翻蓋	開啓		

9 處置



回收或妥善處置電子設備。處置電子設備前，請取出所有電池。請勿將電子設備丟棄在生活垃圾中。
遵守當地法規。



回收或妥善處置電池。請勿將電池丟棄在生活垃圾中。
遵守當地法規。

設備名稱：ViClean-IA 全自動電腦馬桶座		型號（型式）：V15TA301, V15TA401				
單元	限用物質及其化學符號					
	鉛 (Pb)	汞 (Hg)	鎘 (Cd)	六價鉻 (Cr+6)	多溴聯苯 (PBB)	多溴二苯醚 (PBDE)
電路板	超出 0.1 wt %	○	○	○	○	○
電源線材及連接端子	○	○	○	○	○	○
塑膠外殼元件	超出 0.1 wt %	○	○	○	○	○
水加熱裝置	超出 0.1 wt %	○	○	○	○	○
烘乾裝置	超出 0.1 wt %	○	○	○	○	○
噴嘴組件	超出 0.1 wt %	○	○	○	○	○
給水軟管	超出 0.1 wt %	○	○	○	○	○

備考1. “超出0.1 wt %”及“超出0.01 wt %”係指限用物質之百分比含量超出百分比含量基準值。
備考2. “○”係指該項限用物質之百分比含量未超出百分比含量基準值。
備考3. “—”係指該項限用物質為排除項目。

ZH-CN

顏色和尺寸在一般公差範圍內。我們保留對產品進行技術和顏色修改的權利。

Publishing Information

Villeroy & Boch AG

Saaruferstrasse

66693 Mettlach

Germany

www.villeroy-boch.com

Downloading and using images from our pages is not permitted without the written permission of Villeroy & Boch AG.

Copyright

Villeroy & Boch AG

Liability

The content of our pages has been prepared with great care. However, we cannot accept responsibility for the correctness, completeness and up-to-date status of the content.

Villeroy & Boch AG is responsible for its own content, which it makes available for use in accordance with the general legal statutes. This content of its own is to be differentiated from the content provided by other service providers using cross-references (“links”). If we become aware that the linked content would trigger civil or criminal responsibility, we will delete these links.



This product complies with BSMI certification.

The declaration of conformity certificate can be obtained from Villeroy & Boch.

Contents

1	General Information	30
1.1	Conventions used.....	30
1.2	Target group.....	31
1.3	Guarantee.....	32
2	Safety.....	33
2.1	Intended use.....	33
2.2	Reasonably predictable misuse.....	33
2.3	General safety instructions.....	33
3	Technical Data.....	38
4	Product Description.....	39
5	Operation	41
5.1	Wash settings.....	42
5.2	Stop	43
5.3	Flushing.....	43
5.4	Deodorizer.....	44
5.5	Dryer setting	44
5.6	Lid and seat setting	44
5.7	Nightlight.....	45
5.8	Nozzle UV sterilization	45
5.9	Memory function.....	46
5.10	Antibacterial.....	46
5.11	Pre-flushing function	46
5.12	Side control knob operation.....	46
5.13	Expert mode	47
5.14	Nozzle cleaning	47
5.15	Pairing the remote control.....	47
6	Replacing the batteries.....	48
7	Care and maintenance.....	49
7.1	General maintenance instructions.....	49
7.2	Nozzle cleaning	50
7.3	Emergency flushing	51
7.4	Filter cleaning	51
8	Troubleshooting.....	52
9	Disposal.....	54

1 General Information

Thank you for choosing one of our high-quality products.

Read the installation and operating instructions carefully before installing and using the unit. The installation and operating instructions should always be kept in a location that is easily accessible by the user.

Check the products for damage and completeness before installation. Any apparent faults can no longer be rectified after installation has taken place.

1.1 Conventions used

Safety instructions



Warning!

Warning of potential danger.
Severe bodily injury or death are possible.



Caution!

Warning of a potentially dangerous situation.
Slight bodily injury or material damage are possible.



Important

Other useful information and advice.

Action instructions

Steps to be carried out are shown as a numbered list. The sequence of the steps must be complied with.

For example:

1. Action step
2. Action step

The results of an action instruction are shown as follows:

For example:

- ⇒ Arrow
- ⇒ Arrow

List

Lists without a fixed chronological sequence are shown as sets of bullet points.

For example:

- Item 1
- Item 2

1.2 Target group

The target groups of these operating instructions are the users of the product.

Users:

This appliance may be used by children and by people with reduced physical, sensory or mental capabilities or a lack of experience and/or knowledge, provided they are supervised or instructed on safe use, and have understood the possible dangers. Children should not play with the unit.



Warning!

Cleaning and user maintenance shall not be performed by children without supervision.

1.3 Guarantee

Your new ViClean-IA shower toilet was designed and manufactured with the utmost care and closest attention to detail. It boasts high quality, durability and pleasing elegance. For this we give you our word and a 12-months guarantee.

We refuse guarantee claims in the following cases:

- Damage or loss due to force majeure such as fire, earthquakes, floods, storms or other influences such as environmental pollution, gas damage (hydrogen sulphide gas), salt damage and voltage variations
- Damage or loss due to installation, if this is not carried out in accordance with the installation instructions
- Damage or loss due to any improper use, misuse, disregard of the operating instructions or improper/lacking maintenance of the product in breach of the specifications in the operating instructions
- Damage or loss resulting from modification, disassembly and destruction of the product
- Damage or loss through water spots, deposits or foreign bodies contained in the water system
- Damage or loss due to the quality of water in the product's region of use
- Damage or loss through incorrect installation or dismounting after installation
- Damage or loss through hazardous environments
- Damage or loss through external influences (e.g. deformation of the lid)
- Damage or loss through animals or insects
- Damage or loss through freezing of the product
- Damage or loss through unspecific power supply (voltage, frequency) and electromagnetic waves generated outside the product (e.g. by high-voltage lines or accessories)
- Damage or loss through loss of battery power
- Damage or loss through wear and tear (e.g. of filter, O-ring or seal)

2 Safety

2.1 Intended use

The appliance constitutes Class I electrical equipment and must be earthed. It may only be used in dry environments. If the appliance is used in a bathroom, adequate ventilation must be ensured. Install an exhaust fan or venting system to this end.

Intended use also includes:

- Compliance with all operating instructions.
- Compliance with all installation instructions.
- Exclusive use of original spare parts.
- Exclusive use of the product indoors.

ViClean-IA may only be used with fresh water. Dirt particles in the water can block the filter, hoses and nozzles.

2.2 Reasonably predictable misuse

Any use other than that listed under “Intended Use”, or use which goes beyond this, is considered improper.

The manufacturer accepts no liability whatsoever for damage arising from improper use or misuse; the user bears the sole responsibility.

2.3 General safety instructions

Electricity



Warning!

Danger of electrocution!

Touching live parts can lead to severe injury and even death.

- The appliance is designed to operate on 110 V, 60 Hz. The product may only be installed and repaired by a qualified specialist.
- When carrying out work, make sure the mains power supply is switched off and secured against reconnection.



Warning!

Danger of electrocution during cleaning and maintenance!

Touching live components (110 V, 60 Hz) during cleaning and maintenance can lead to severe injury and even death.

- Take care not to touch live parts (110 V, 60 Hz) during cleaning and maintenance.



Warning!

Danger of electrocution!

Live components that have not been fitted or fixed properly can lead to severe injury and even death.

- All electrical and electromagnetic components, and those needed for installation (with the exception of the remote control), must be attached to the toilet safely in accordance with the installation instructions and applicable legal regulations in the country of installation.
- To prevent injury and even death, all live parts must be attached to the toilet safely in accordance with the installation instructions and applicable legal regulations in the country of installation.

Heat



Warning!

Danger of explosion!

Sources of heat in the immediate surroundings of the toilet or remote control can lead to heat development in the product and explosions.

- Do not place any sources of heat in the immediate surroundings of the toilet or remote control.

Cleaning



Warning!

Cleaning and user maintenance shall not be performed by children without supervision.



Caution!

Material damage due to cleaning agents!

Contact of the shower toilet with non-pH neutral cleaning agents or cleaning agents that contain chlorine or which are abrasive as well as the use of cleaning utensils with a rough surface can lead to damage.

- Only use water, a mild neutral cleaner and cloths with a soft surface to clean the shower toilet.
- If the shower toilet comes into contact with aggressive cleaning agents or sanitary cleaners, wipe them off immediately with wet cloth.



Caution!

Material damage due to cleaning agents!

The seat and lid can be damaged by contact with cleaning agents.

When cleaning, make sure that the seat and lid remain up until the cleaning agent has been wiped away.



Caution!

Material damage due to water!

The remote control can be damaged by contact with water.

- Never immerse the remote control in water.
- Do not clean the remote control in a dishwasher.



Important

To clean the toilet seat, use a mild soap solution and make sure that the seat and hinges are not left damp.

Therefore, dry the toilet seat and hinges with a soft cloth.

Operation



Important

In the event of a product malfunction, switch off the toilet with the appropriate switch (see chapter "Product description") and turn off the water supply. Malfunctions can be:

- Smoke development
- Water leaks
- Noise development



Important

Always use the new hose supplied with this appliance. Any old hose that has already been in use should not be reused.

The inlet hose should not be bent excessively, so as not to affect the water supply and cause product malfunction.



Important

- The system conforms to the requirements for Protection Class I equipment.
- To avoid danger, the power supply cord must be replaced by the manufacturer, its service agents or similarly qualified persons if damaged.
- All parts must be mounted in the correct position.
- Do not use adhesives as a fixing method.



Important

In regions with hard water, limescale build-up can impair the performance of the product.

Check the water quality in your region. Installation of a water softener is recommended when the water hardness $\geq 14^\circ$ dH (2.5 mmol/l).



Important

When the seat and lid are down, avoid subjecting them to weight of any kind that does not conform to intended use, e.g. do not stand on the seat or lid or support yourself with one leg.



Important

Dispose of leaking batteries correctly using gloves. Avoid skin contact. Wipe off residues with a moist cloth.



Important

Only use LR03/AAA batteries. Never use rechargeable batteries.



Important

Persons with physical, perceptual or intellectual disabilities or lack of experience and/or knowledge cannot use this product.

The above people can use this product under the condition of receiving supervision or guidance on safe use from their safety supervisor.



Important

Children, the elderly, people with physical and intellectual disabilities or lack of experience, must be accompanied by a guardian before use.
Do not let children play with appliances, so as not to cause personal injury or damage the appliance.



Important

Do not place fireworks or other flammables nearby, or a fire may occur.
Do not put lighted cigarettes or other burning substances into the toilet in case of a fire!



Important

If the power cord becomes damaged, it must be replaced with a dedicated cord or with a dedicated component purchased from the manufacturer or service department.



Important

Power-on reset

After the product is energized, the main board detects the AC signal and performs a reset on the distributor valve. All the lights are on, seat temperature, water temperature, air temperature, water strength and nozzle position return to middle level. Product will enter power-on mode and you will hear a “ding” to prompt a successful initialization, otherwise the sound “dong” indicates the initialization is not successful.



The National Communications Commission (NCC) Warning

According to the "LP0002 Low power RF Equipment Technical Specification section 3.8.2" For the qualified low-power RF motor, any companies or users shall not change the frequency, increase power or change the characteristics and functions of the original design without permission. The use of low-power RF motor must not affect flight safety and interference with legitimate communications; When interference signs are found, they should be deactivated immediately, and continue to be used when there is no interference after improvement.

3 Technical Data

Category		Description
Model		V15TA301(rough in 305mm), V15TA401(rough in 400mm)
Name		ViClean-IA
Power voltage		110 V~ 60 Hz
Rated power		1050 W ※1
Maximum power		1600 W
Remote control battery (2 pcs)		Type: LR03/AAA
Flushing mode of toilet		Automatic flushing, remote control flushing and emergency flushing
Water consumption of toilet		Full flush 4.2 L and eco flush 3.0 L
Wash function	Max water flow rate (when water pressure is 0.2 MPa)	Not less than 500 mL/min
	Water heating temperature	Off/~34-39 °C
		4 levels
	Adjustable nozzle position	5 levels
	Heater power	~1400 W
Water strength	3 levels	
Seat	Seat temperature	Off/~34-39 °C
		4 levels
	Heater power	~40 W
Dryer	Dryer temperature	Off/~35-55 °C ※3
		4 levels
	Air flow	~0.2 m ³ /min
		3 levels
Heater power	~350 W	
Deodorization	Method	Catalyst
Waterproof level		IPX4
Water inlet temperature		4-35 °C
Operating ambient temperature		4-40 °C
Water pressure requirement		0.08 MPa (dynamic pressure)-0.75 MPa (static pressure) ※2
Dimensions (L x W x H)		685x400x470 mm
Length of power cord		1.6 m
Weight		45 kg

※1 Inlet water temperature is 15 °C.

※2 The test conditions for water pressure requirements are measured the angle valve provided by the product under dynamic pressure of 0.08 MPa and flow rate of 13.8 L/min.

※3 Air temperature was measured near the air outlet according to specified method.

4 Product Description

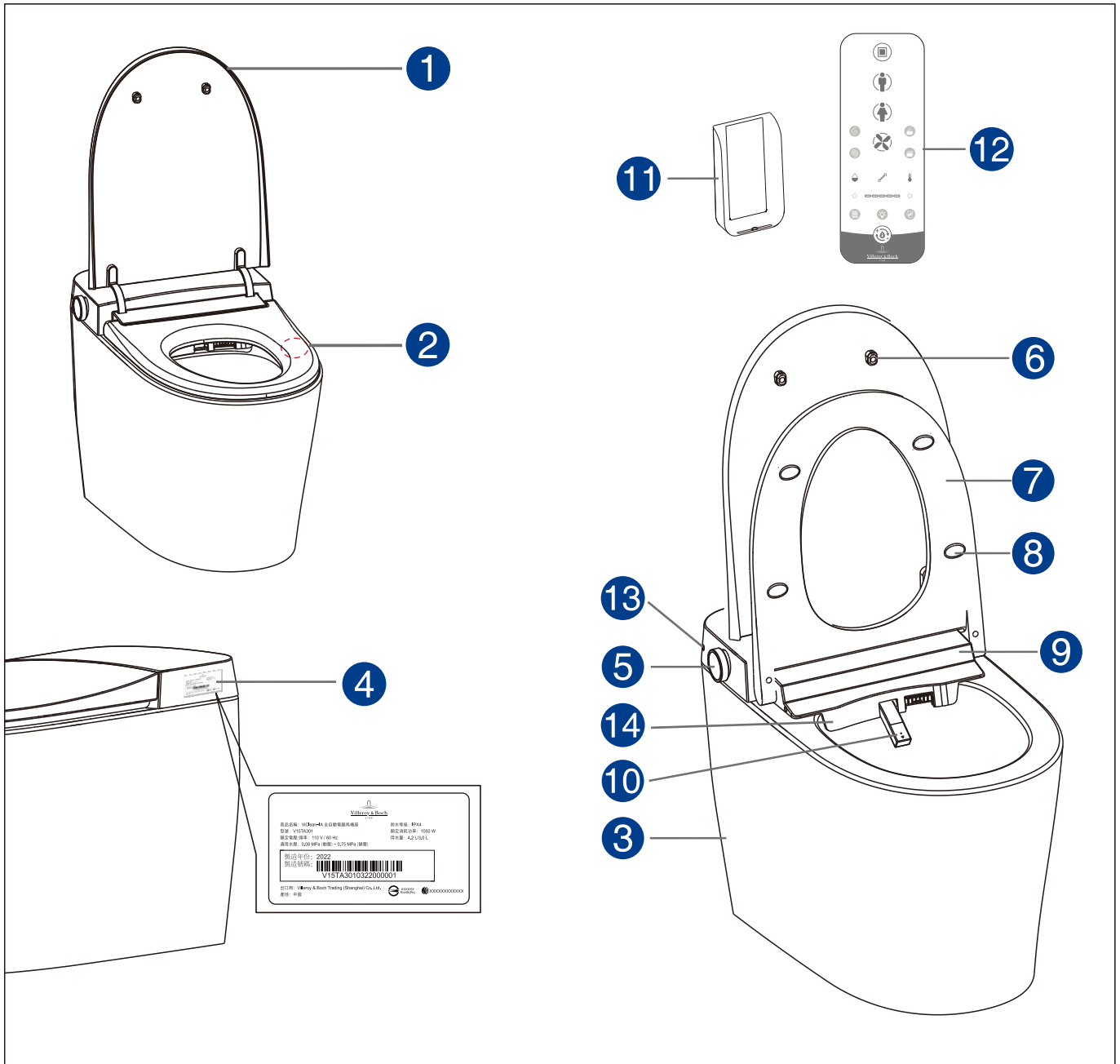

- | | |
|--|--------------------------------|
| 1 Lid | 8 Seat buffer |
| 2 Seat sensor | 9 Rear cover |
| 3 Ceramic body | 10 Nozzle |
| 4 Nameplate with S/N | 11 Remote control wall bracket |
| 5 Side control knob (Status indicator) | 12 Remote control |
| 6 Lid buffer | 13 Light-receiving window |
| 7 Seat | 14 Ambient light (bottom) |

Nozzle settings

The following settings can be selected for the Ladywash and Rearwash functions.:

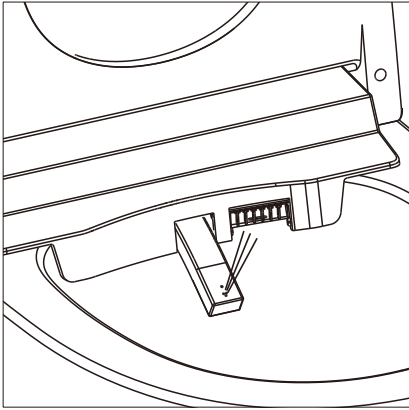

Standard
No nozzle movement

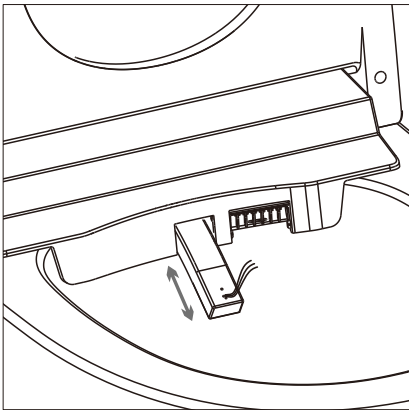

Oscillating
The nozzle moves forward and backward

5 Operation

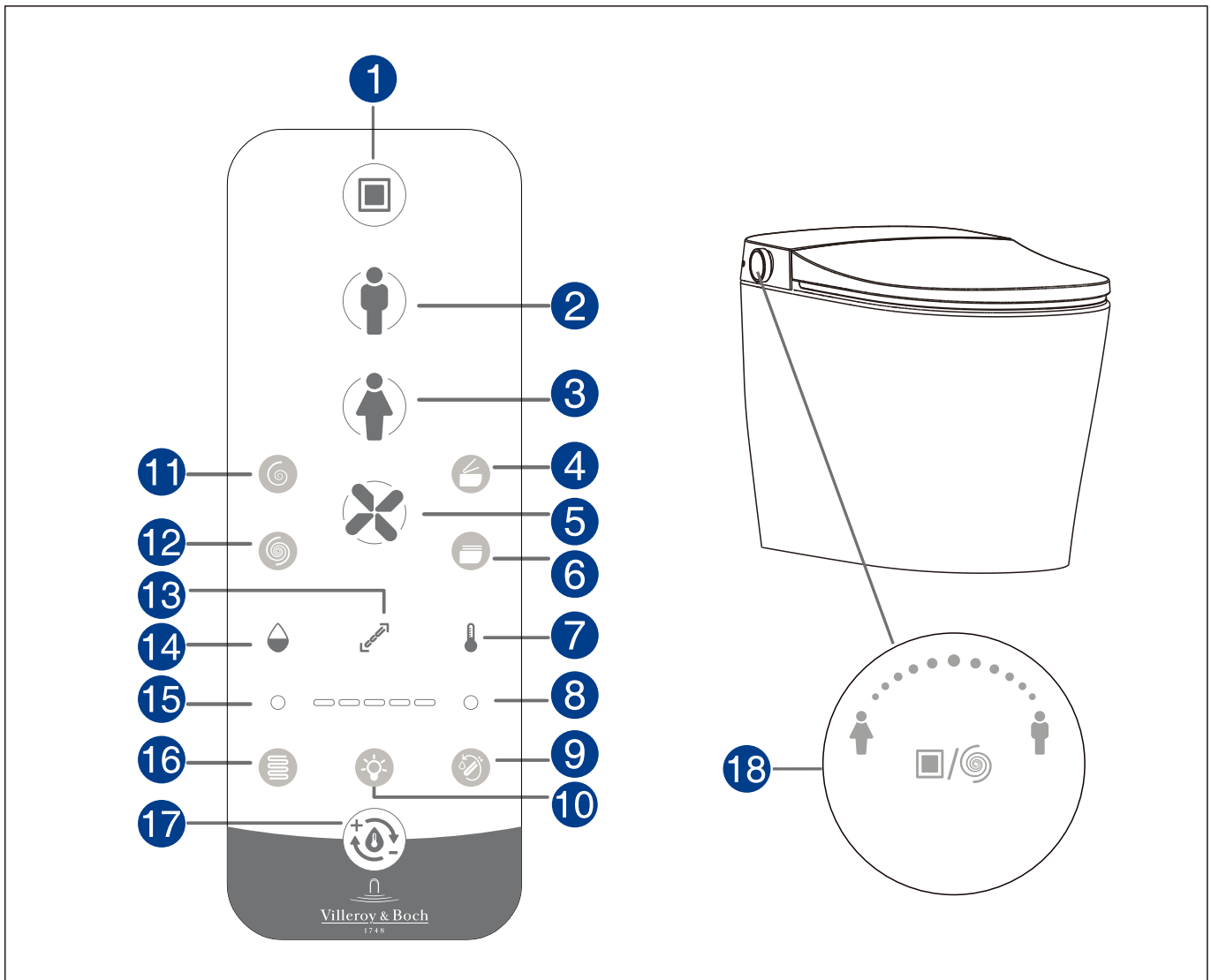

- | | |
|--------------------------------|--|
| 1 Stop | 10 Nightlight setting |
| 2 Rearwash | 11 Eco Flush |
| 3 Ladywash | 12 Full Flush |
| 4 Open lid/seat | 13 Nozzle position adjustment |
| 5 Air drying | 14 Water strength adjustment |
| 6 Close lid/seat | 15 Decrease setting |
| 7 Water temperature adjustment | 16 Seat heating adjustment |
| 8 Increase setting | 17 Hot and cold massage |
| 9 Nozzle cleaning | 18 Side control knob operation (refer to chapter 5.12) |

5.1 Wash settings

The wash function is only available when the user is sitting on the seat.

Rearwash

The initial mode is oscillating mode when the wash is activated, the knob indicator light is blue, press the stop button to stop or wait for 4 minutes until the wash stop automatically.

Button	Frequency	Result
	1 x	Oscillating mode.
	2 x	Standard mode.

Ladywash

The initial mode is oscillating mode when the wash is activated, the knob indicator light is pink, press the stop button to stop or wait for 4 minutes until the wash stop automatically.

Button	Frequency	Result
	1 x	Oscillating mode.
	2 x	Standard mode.



Hot and cold massage

In the mode, the water temperature will alternately changes between hot and cold. This function can only be turned on/off during rearwash/lady wash.

Button	Frequency	Result
	1 x	Hot and cold massage mode turned on.
	2 x	Hot and cold massage mode turned off.

Nozzle position

The nozzle position can be adjusted between five different levels. The initial position is the level set last time.

Button	Frequency	Result
	1 x	Setting the nozzle position, the LED light indicates the position of the nozzle.
	1 x	Move the nozzle position forward by one level.
	1 x	Move the nozzle position backward by one level.

Water strength

Water strength can be adjusted between three different levels. The initial strength is the level set last time.

Button	Frequency	Result
	1 x	Setting the water strength, the LED light indicates the water strength setting.
○ ○○○○○ ●	1 x	Increase the water strength by one level.
● ○○○○○ ○	1 x	Decrease the water strength by one level.

* Water strength can also be adjusted by the side control knob, pls refer to chapter 5.12.

Water temperature

Water temperature can be adjusted between four different levels(including no heating). The initial temperature is the level set last time.

Button	Frequency	Result
	1 x	Setting the water temperature, the LED light indicates the water temperature setting
○ ○○○○○ ●	1 x	Increase the water temperature by one level.
● ○○○○○ ○	1 x	Decrease the water temperature by one level.

5.2 Stop

Button	Operation	Result
	Press stop	Stop wash or air dryer function.

5.3 Flushing

Remote control flushing

A short time is needed for re-filling of water tank before it can flush again.

Full flush

Button	Frequency	Result
	1 x	Start full flush, the indicator light is blue during flushing.

ECO flush

Button	Frequency	Result
	1 x	Start eco flush, the indicator light is blue during flushing.

Automatic flushing

Function	Condition	Result
Automatic flushing after leaving the seat	Leave the seat	When there is no flush being seated, a short time after leaving seat, it will automatically full or eco flush once according to the sitting time.
Automatic closing the seat, lid and flushing	Lid and seat are open	After leaving seat, microwave detect that no one approaching for a short time, it will automatically flush once while closing lid and seat.



5.4 Deodorizer

The deodorization is automatically turned on when you sit down, it will be suspended when the washing or air drying function is activated, the deodorization will automatically restart and stop 3 minutes after leaving the seat.

5.5 Dryer setting

The air drying function is only available when the user is sitting on the seat.

The warm air temperature can be adjusted between four different levels (including no heating). The initial temperature is the level set last time.

Button	Frequency	Result
	1 x	Start the dryer, the LED light indicates the dryer temperature setting.
	1 x	Increase the dryer temperature by one level.
	1 x	Decrease the dryer temperature by one level.



The wind speed can be adjusted among three different levels.

Button	Result
	Press the "air drying" button to activate the air drying, and then press the button again to adjust the wind speed from low to high.

5.6 Lid and seat setting

The open/close lid and seat function is only available when the user is not sitting on the seat.

Open/close lid and seat by RC control

Button	Frequency	Result
	1 x	If the lid is closed, open the lid.
		If the lid is up, open the seat.
		If the lid and seat are both up, No action.
	1 x	If the lid is closed, No action.
		If the lid is up, close the lid.
		If the lid and seat are both up, close the lid and seat.

Do not interfere with the self-checking action of the lid and seat during the power-on reset.



Automatic open/close lid and seat

Function	Trigger condition	Result
Automatic opening of lid	The lid is closed, microwave detects people approaching.	Lid will be opened automatically.
Automatic closure of lid	The lid is up and seat is closed, no people is detected by microwave within short time.	Lid will be closed automatically.
Automatic closure of lid and seat	The lid and seat are both up, no people is detected by microwave within short time.	Lid and seat will be closed automatically and flush.

After the seat cover is completely closed, a short time interval is required to automatically sense the opening of the seat cover again.

Seat heating





The seat temperature can be adjusted between four different levels.

Button	Frequency	Result
	1 x	Start the seat heating, the LED light indicates the seat temperature setting.
	1 x	Increase the seat temperature by one level.
	1 x	Decrease the seat temperature by one level.

5.7 Nightlight

The nightlight can be adjusted between three different settings. (Off>Auto>On)

The night light will turn on and off by itself according to the ambient brightness in automatic mode. In automatic and on mode, The nightlight only turns on when the lid is open, closing lid will turn off the nightlight.

Button	Frequency	Result
	1 x	Start the Nightlight setting, the LED light indicates current setting.
	1 x	Night light will be controlled by light sensor, 3 LEDs light up.
	1 x	Nightlight is on, 5 LEDs light up.
	1 x	Nightlight is off, No LED light up.

5.8 Nozzle UV sterilization

Operation: Automatically after leaving the seat

Function description: Nozzle retracts to its initial position after leaving the seat, after 10s, the nozzle will automatically start the UV sterilization for 3 minutes. The indicator light is purple during sterilization and the it will stop if being seated.

5.9 Memory function

After re-power, the water temperature, water strength, air temperature, seat temperature and nozzle position will be restored to mid level. Nightlight restore to auto mode.

The product will keep the setting last time if there is no re-power.

5.10 Antibacterial

Antibacterial material is used in the seat

Antibacterial (※The antibacterial cannot be effective when the bacteria do not directly touch the surface of the antibacterial processed product.)

Anti-bacterial efficacy	The plastic materials used in the seat can suppresses bacterial growth on the product surface. The material was tested at JNLA-registered laboratory in accordance with the test for antibacterial activity specified by JIS Z 2801, and the result has satisfied the antibacterial efficacy specified by JIS Z 2801. This does not target the secondary effects such as infection prevention, antifouling, mold prevention, deodorization, and slime prevention.
-------------------------	---

5.11 Pre-flushing function



The pre-flushing function is automatically activated after being seated. A small amount of water will rinse the inner ceramic surface and pre-wet the bowl surface.

5.12 Side control knob operation



Function	Status	Operation	Result
Enter power on mode	Toilet is in stand-by mode	Long press the knob for 3s	Enter power on mode
Enter stand-by mode	Toilet is in power on and no wash or air drying	Long press the knob for 3s	Enter stand-by mode
Stop	Toilet is In washing or air drying	Short press the knob	Stop washing or air drying
Smart rear wash	In power on mode, being seated, without washing or air drying	Rotate clockwise more than 45°	Enter “Smart rear wash mode”, indicator light is blue
Smart lady wash	In power on mode, being seated, without washing or air drying	Rotate counterclockwise more than 45°	Enter “Smart lady wash mode” indicator light is pink
Water strength	In rear wash or lady wash	Rotate clockwise more than 45°	Increase water strength
		Rotate counterclockwise more than 45°	Decrease water strength
Wind speed	In air drying	Rotate clockwise more than 45°	Increase wind speed
		Rotate counterclockwise more than 45°	Decrease wind speed
Flush	In power on mode, without washing or air drying	Short press the knob	Flush and the indicator light is blue

5.13 Expert mode

Expert mode is used to access the following less-used functions and settings. Starting the expert mode:

- ▶ Press and hold both the "  " button and "  " for 3 seconds. The LEDs blink 3 times then go out indicating that Expert Mode has been activated.



Automatic Open/Close Lid: turn on and off in expert mode

Button	Frequency	Result
	1 x	Start automatic open/close lid setting, the LED light indicates current setting.
	1 x	Automatic open/close lid is on, a long beep in the toilet .
	1 x	Automatic open/close lid is off, two short beeps in the toilet.

Or flush after lid closure: turn on and off in expert mode

When the flush after lid closure is turned on, the lid will close first and then flush is performed when user press the flush button.

* There is no automatic flush in this mode.

Button	Frequency	Result
	1 x	Start flush after lid closure setting, the LED light indicates current setting.
	1 x	Flush after lid closure is on,automatic flush is off, a long beep in the toilet.
	1 x	Flush after lid closure is off, automatic flush is on, two short beeps in the toilet.

- ▶ Press the "  " button to exit expert mode, or automatically exit expert mode without any buttons for about 10 seconds.

5.14 Nozzle cleaning

For more information on nozzle cleaning, please refer to [chapter 7.2, "Nozzle cleaning"](#).

5.15 Pairing the remote control

1. Unplug the product, press and hold the stop button on the remote control until the indicator light flashes, then release it.
2. Place the remote control close to the product and power on the product.
3. The level indication light stops flashing and then stays on. The pairing is successful.

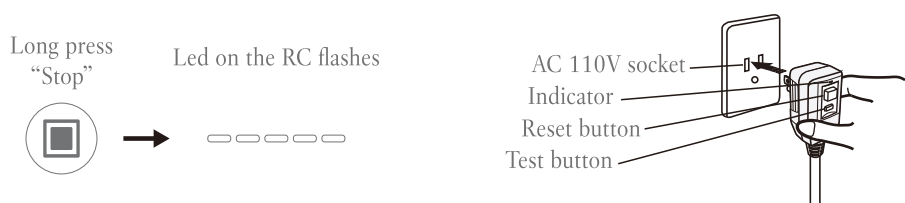

6 Replacing the batteries

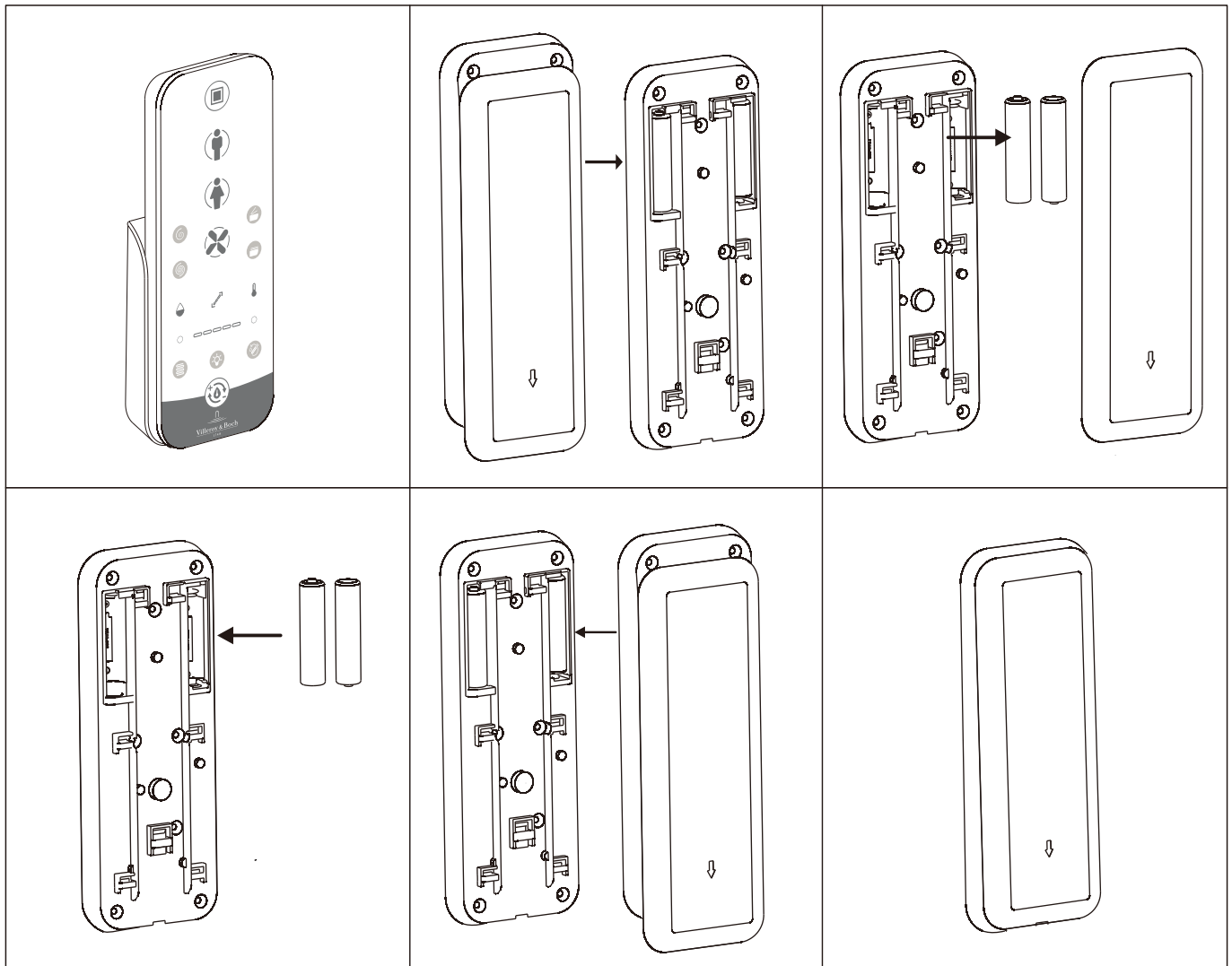

Important

Dispose of leaking batteries correctly using gloves. Avoid skin contact. Wipe off residues with a moist cloth.



Important

Only LR03/AAA batteries can be used. Never use rechargeable batteries.

For correct disposal of the batteries, see [chapter, "Disposal"](#).

7 Care and maintenance



Caution!

Material damage due to cleaning agents!

Contact of the shower toilet with non-pH neutral cleaning agents or cleaning agents that contain chlorine or which are abrasive as well as the use of cleaning utensils with a rough surface can lead to damage.

- Only use water, a mild neutral cleaner and cloths with a soft surface to clean the shower toilet.
- If the shower toilet comes into contact with aggressive cleaning agents or sanitary cleaners, wipe them off immediately with wet cloth.



Caution!

Material damage due to water!

The remote control may be damaged by contact with water.

- Never immerse the remote control in water.
- Do not clean the remote control in the dishwasher.



Please empty the water tank and take out the battery in the remote control when you are not using the product for more than two weeks.

Empty the water tank

Please follow the steps below to drain the water inside the tank:

1. Close the water supply angle valve, and then press the flush button to flush the toilet twice or above to drain the tank.
2. Unplug the product 30s after the last flush.

7.1 General maintenance instructions

For daily cleaning, we recommend a soft, non-abrasive sponge or cloth.



Important

To clean the toilet seat, use a mild soap solution and make sure that the hinges are not left damp.

Therefore, dry the toilet seat and hinges with a soft cloth.

Care instructions for persistent dirt

Thanks to the easy-care surface of ViClean-IA, you can achieve optimal hygiene and fresh clean surfaces without resorting to aggressive detergents. If you wish to use a detergent, we recommend a standard all-purpose cleaner.



Caution!

Material damage due to cleaning agents!

The seat and lid can be damaged by contact with cleaning agents.

When cleaning, make sure, that the seat and lid remain up until the cleaning agent has been wiped away.

7.2 Nozzle cleaning

Extending the nozzle

1. When you are not seated press the nozzle cleaning button "  " on the RC control.

► The nozzle extends and can be cleaned by a wet cloth.

2. When you sit down, press any button on RC or toilet or after four minutes, the nozzle will retract automatically.

✘ Do not use excessive force, otherwise the nozzle will be damaged.

✘ When the nozzle is clogged and cannot be cleared, it is recommended to replace it with a new nozzle tip.

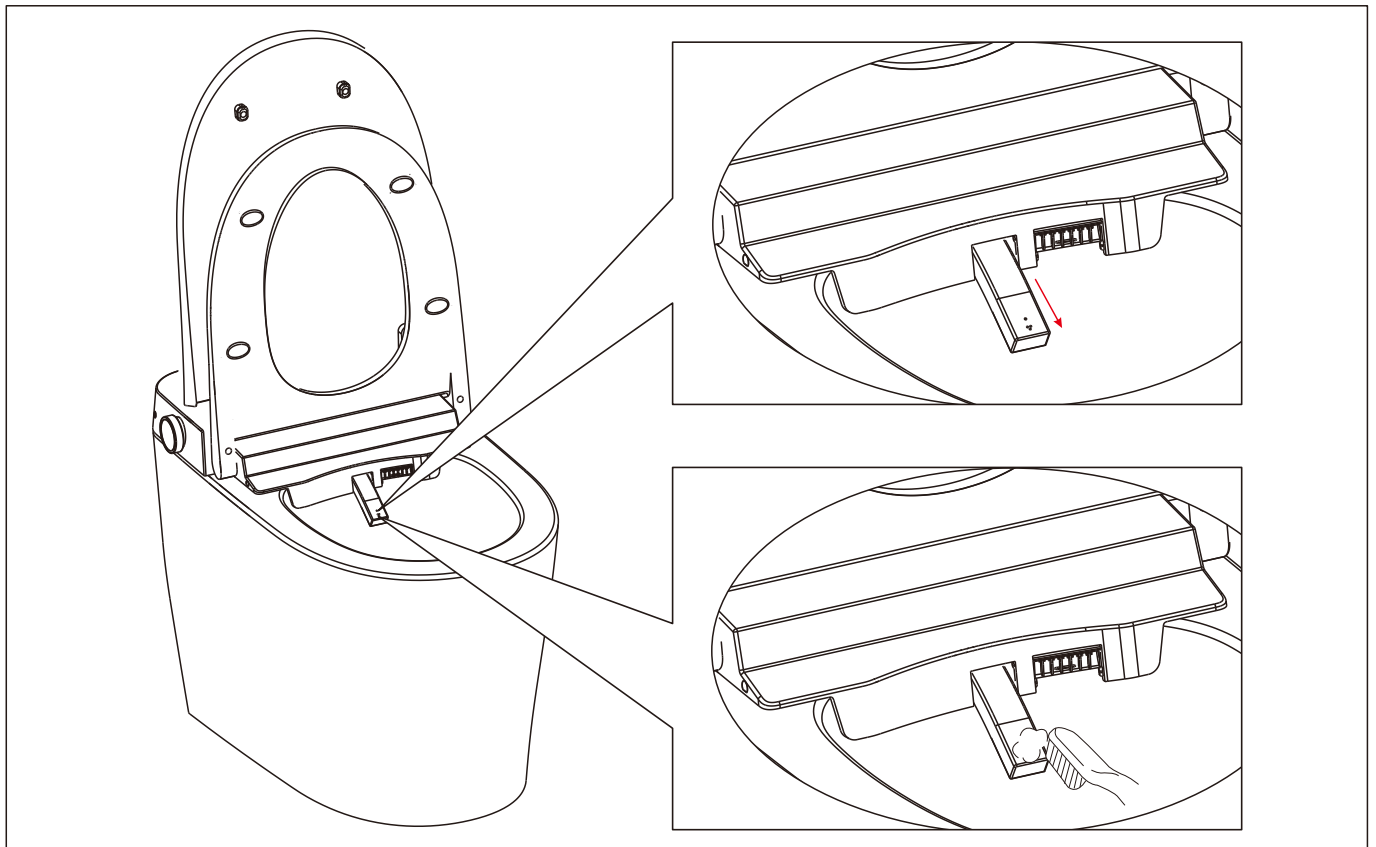

7.3 Emergency flushing

In case of a power failure, short-press the side control knob to start an emergency flush.

7.4 Filter cleaning

- 1** Close the water valve to stop water supply.

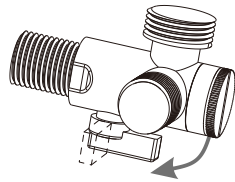

- 2** Disassemble the filter element.

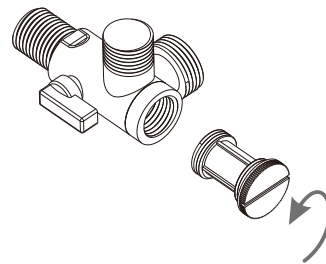

- 3** Clean the filter element with toothbrush and soft cloth.



- 4** Mount the filter element.

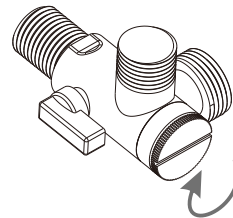

8 Troubleshooting

Troubleshoot as follows:

Troubleshooting	
Check water supply	Is the water supply in your house normal?
	Is the main valve closed?
Check the power supply	Is there a power outage?
	Check the leakage circuit breaker in the bathroom and reset (if applicable).
Reset ViClean-IA	Close the ViClean-IA and turn it on one minute later.
Check remote control for normal operation	Check if the batteries are exhausted. If they are flat, replace the batteries. Prevent the remote control from coming in contact with water.

Troubleshooting as follows.

Failure	Possible solutions
ViClean-IA fails to work	Check the power supply.
ViClean-IA does not respond to remote control	Check whether the batteries are correctly placed in the remote control.
	Check whether the corresponding indicator light of water intensity, nozzle position and temperature on the remote control are lit up when the button is pressed. If not, replace the batteries.
ViClean-IA does not respond to remote control even when the lights turn on	Pair the remote control. (Refer to 5.15)
	If unable to operate, please contact our customer service.
Insufficient water pressure	Increase the setting by remote control.
	Clean the filter. (Refer to 7.4 Filter Cleaning)
	If necessary, tighten all waterway connecting nuts.
Insufficient water temperature	Increase the water temperature by remote control.
	If the temperature in the bathroom is very low, the initial cleaning water temperature will also be very low.
	If unable to operate, please contact our customer service.

Failure	Possible solutions
No seat heating	Check whether the seat temperature is set off, use the remote control to increase the seat temperature.
The nozzle cannot extend	Close the ViClean-IA and turn it on a few seconds later.
	If unable to operate, please contact our customer service.
Nozzle extends too slowly	When the ladywash or the rearwash function is used, the nozzle will be cleaned for a few seconds before extending. This is normal, not a failure.
The nozzle suddenly stopped spraying water.	After 240 seconds, the cleaning is stopped and the nozzle is automatically retracted. It's normal.
Emergency flushing function not working	If unable to operate, please contact our customer service.

Factory defaults					
Water temperature	Mid level	Water strength	Mid level	Nozzle position	3 level
Seat temperature	Mid level	Air temperature	Mid level	Nightlight	Auto
Automatic flushing	On	Automatic open/close lid	On		

9 Disposal



Recycle electronic equipment, or dispose of properly. Remove any batteries before disposing of electronic equipment. Do not dispose of electronic equipment in household waste.

Observe local regulations.



Recycle batteries, or dispose of properly. Do not dispose of batteries in household waste.

Observe local regulations.

EN

Colors and dimensions are within the general tolerance range. We reserve the right to modify the features and color of the products.

Villeroy & Boch

出口商: Villeroy & Boch Trading (Shanghai) Co., Ltd.

地 址: 上海市長寧區古北路555弄8號1001室

電 話: +86 400-820-1748

進口商: 楠弘貿易股份有限公司

地 址: 高雄市前鎮區復興四路12號11樓之3

電 話: 07-3382000

Exporter: Villeroy & Boch Trading (Shanghai) Co., Ltd.

Address: Room1001, No.8, Lane 555, Gu Bei Road,
Chang Ning District, 200051, Shanghai, China

Importer: Lafon Trading Co.,Ltd.

Address: 11F-3, No.12, Fu-Hsing 4th Rd., Chien-Chen Dist.,
Kaohsiung 80661, Taiwan ROC

Phone: 07-3382000

WWW.VILLEROY-BOCH.CN