



Quality of life since 1825

Toilet Nautic 1546 - S-trap, high model, Hygienic Flush

Dual flush 4/2L, without seat, C+.

Product features

CERAMICPLUS



- Ceramicplus: quick and eco-friendly cleaning
- With open flush edge for simplified cleaning
- Elevated seat height for better comfort

Article numbers

Art-no.
GB1115462R1203

EAN
7391530067438

Packaging information

Length: 680 mm | Width: 360 mm | Height: 980 mm

Weight: 31 kg

Weight: 1 pc

Assembling & Care

Floor mounting with four stainless steel screws and plastic caps. Or floor mounting with glue. The rounded cistern and the small outer dimensions makes it suitable for corner installations. Please refer to the installation manual. Fittings included.

Energy labeling and certifications

- CE approved, SS-EN 33 dimensioning and SS-EN 997 function

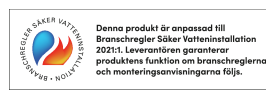

Technical information

- CO2 Footprint: 71.93 kg
- Flushing - water quantity: 2/4 L Dobbeltskyl
- Trap à Outlet: Hidden trap S-Trap
- Standard connection dimension: c/c 155mm sitsfäste

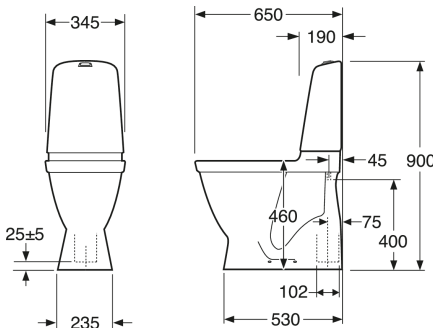

Spare parts



Toilet Nautic HF yr 2017-
(Rev 3. 2024-01-09)

No.	Product	Art-no.
1	Complete inner tank	GB19299N0100
2	Cistern housing	GB185580001200
3	Valve housing, flush valve	9GN00100
4	Fill valve	9GN03200
6	Membrane	9GN00300
7	Knapphus high Duo	9GN00561
8a	Knapphus high Single	9GN00661
8b	Flush button - replacement button vandal, Nautic 2017-	GB19299NNV36
9	Knapphus low Duo	9GN01161
10a	Screw bag	GB1929900365
10b	Plug bag, complete	GB19299P0207
11	Valve housing gasket	9GN00400
12	Floor fixation kit	92242500
13	Cistern fixation kit	92226100
14a	Toilet seat Nautic 9M24 - Standard	9M246101
14b	Toilet seat Nautic 9M26 - SC/QR	9M26S101
14c	Toilet seat Nautic 9M26 - SC/QR	9M26S136
14d	Toilet seat Nautic 9M25 - Rigid fixings	9M256101
14e	Toilet seat Nautic - Slim seat	8M45S101
15	seat hinges	92095761
15b	seat hinges	92096361
16	Shut-off valve	GB1929900503
17	Cover panel	GB1929903410
21	Soft Close damper	92242400
22	Buffer set	92242001
98	Inlet filter	9GN01400



SMARTER
BATHROOMS

FLOW CHART

FILL VALVE - 9GN00100



A MEMBER OF THE
VILLEROY & BOCH GROUP

Villeroy & Boch Gustavsberg AB
Box 400, 134 29 Gustavsberg
Phone +46 (0)8-570 391 00
www.gustavsberg.com | info@gustavsberg.com